



KISTLER

measure. analyze. innovate.

**Innovative
measurement
technology
for engine
development**

Engine indication

With maximum precision for better engines



Absolute attention for tomorrow's world

Kistler develops measurement solutions consisting of sensors, electronics, systems and services. In the physical border area between emissions reduction, quality control, mobility and vehicle safety, we deliver excellence for a future-oriented world and create ideal conditions for Industry 4.0. We thereby facilitate innovation and growth for – and with – our customers.



Kistler stands for progress in engine monitoring, vehicle safety and vehicle dynamics and provides valuable data for the development of the efficient vehicles of tomorrow.



Kistler measurement technology ensures top performance in sport diagnostics, traffic data acquisition, cutting force analysis and other applications where absolute measurement accuracy is required.



Kistler systems support all steps of networked, digitalized production and ensure maximum process efficiency and profitability in the smart factories of the next generation.

Kistler Group products are protected by several intellectual property rights patents. For more details see: www.kistler.com

Editorial



As globalization increases, it becomes clear: To balance the requirements of a globally networked economy with the right to an intact environment, all representatives from industry and business are called upon to actively develop existing technologies and constantly expand technical know-how. In the automotive sector, we are proud to be able to respond to the needs of the market with a constant stream of new and efficient solutions. Thanks to reliable products and our aspiration for technical excellence, we continue to set standards in process efficiency and future

security. But our commitment expands beyond product development: As one of the world's leading manufacturers of sensors and systems for measuring pressure, force, torque and acceleration, we are committed to focusing on the smallest of details. We thereby create the basis to enable our customers to achieve great things.

Jürg Stadler
Head of Strategic Business Field
Engine R&D

Contents

Kistler indicates

Indication – the key to better engines	4
Indication with Kistler: innovative, precise, economical	5
Fundamentals of indication technology	6
The whole world of engine indication – for exactly your application	8

Indication measuring chain

An integrated system for test bench and vehicle	10
---	----

Measure

High-precision measurement with the optimum sensor solution	12
Customization for crystal clear results	13

Connect

The right position – with and without additional bore	14
Perfect connection for the best data transmission	15

Amplify & Condition

Automatic sensor identification with PiezoSmart	16
Conditioning signals for the test bench – with the SCP	18
Intuitive operation with the graphical user interface	19

Acquire/Analyze

The KiBox – two areas of application, one reliable measurement result	20
--	----

Service

Service tailored to your success	22
At our customers' service across the globe	23



Indication – the key to better engines

Future-oriented solutions for the measurement of cylinder pressure and temperature are the basis for innovation in engine development. It is the measurement and analysis of the pressure curve in the cylinders that supplies the data necessary for optimizing the efficiency, the performance, the emissions and the service life of engines. The better the data, the more valuable the information that is derived from it.

The Advantages of Engine Indication:

- Improved efficiency
- Increased engine performance
- Reduced emissions
- Longer engine lifetime

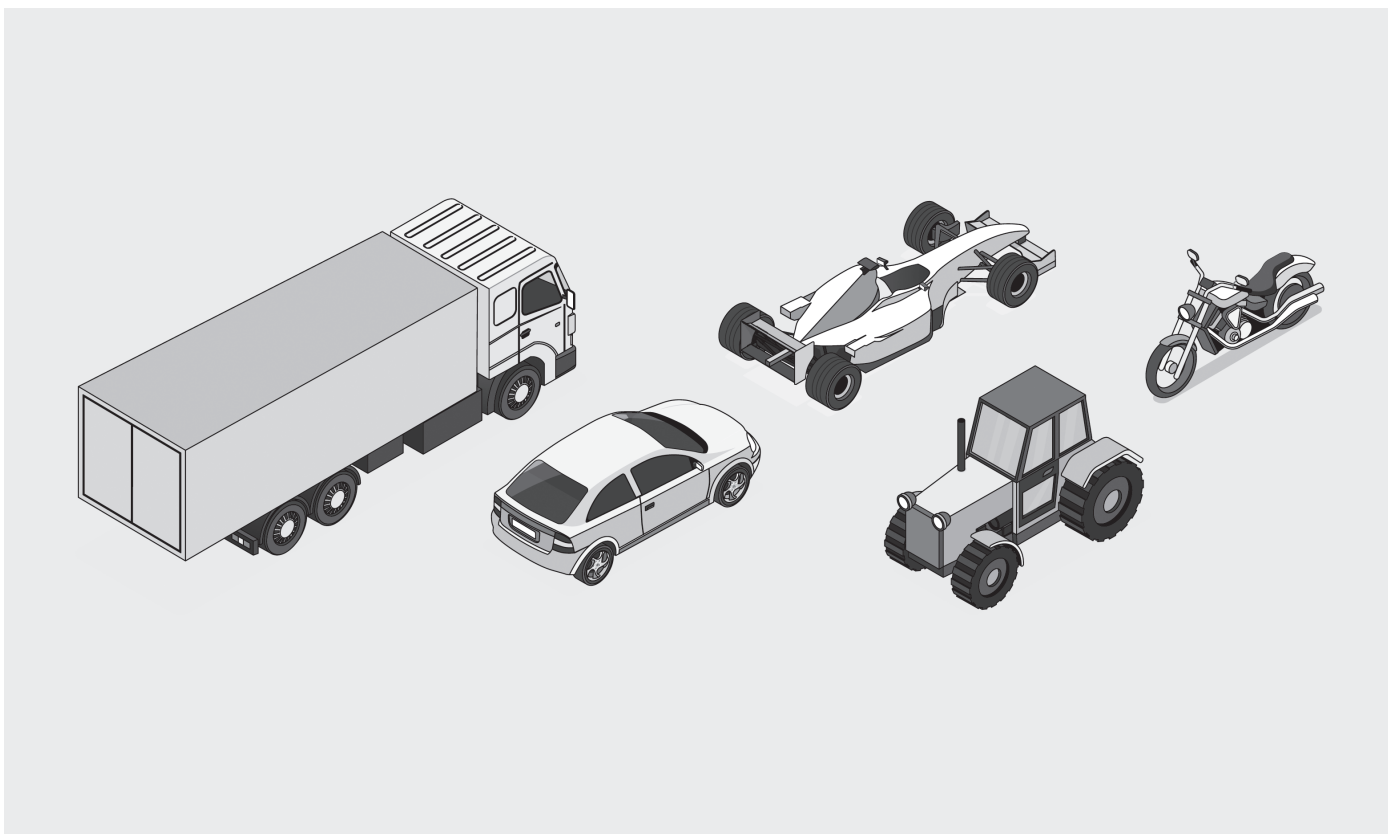

With Kistler's extensive know-how, engine indication can be successfully implemented in any environment.

Indication with Kistler: innovative, precise, economical

Technical excellence that advances your engine development

Kistler has been developing and manufacturing piezoelectric sensors for more than 50 years. Because we are extremely familiar with the dynamic application fields, we have the right solutions for your needs.

Reliable systems for error-free measurement results

Valid measurement data is the basis for increasing engine efficiency. Measuring systems from Kistler are designed to provide you with error-free measurement results from the very first test. PiezoSmart automatic sensor identification plays an important role here.

User-friendly solutions for efficient testing

Efficient and time-saving processes are the basis for the success of your company. With plug-and-play solutions, intuitive user interfaces and modular sensor systems, you can significantly reduce your test cycles.

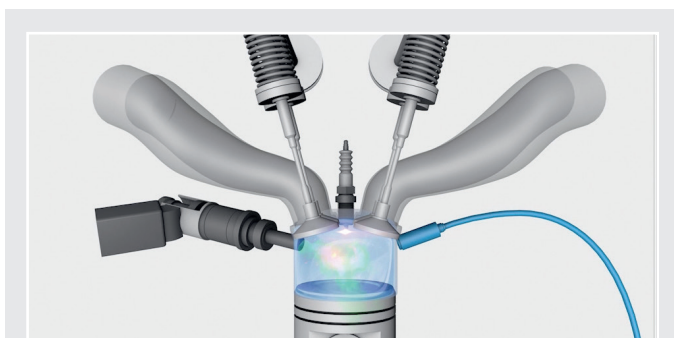

Experience now online: engine indication with Kistler

Experience the innovative Kistler solutions for engine indication in action. Our animation shows you the fast and effective path to successful engine development.
www.kistler.com/engine-testbench

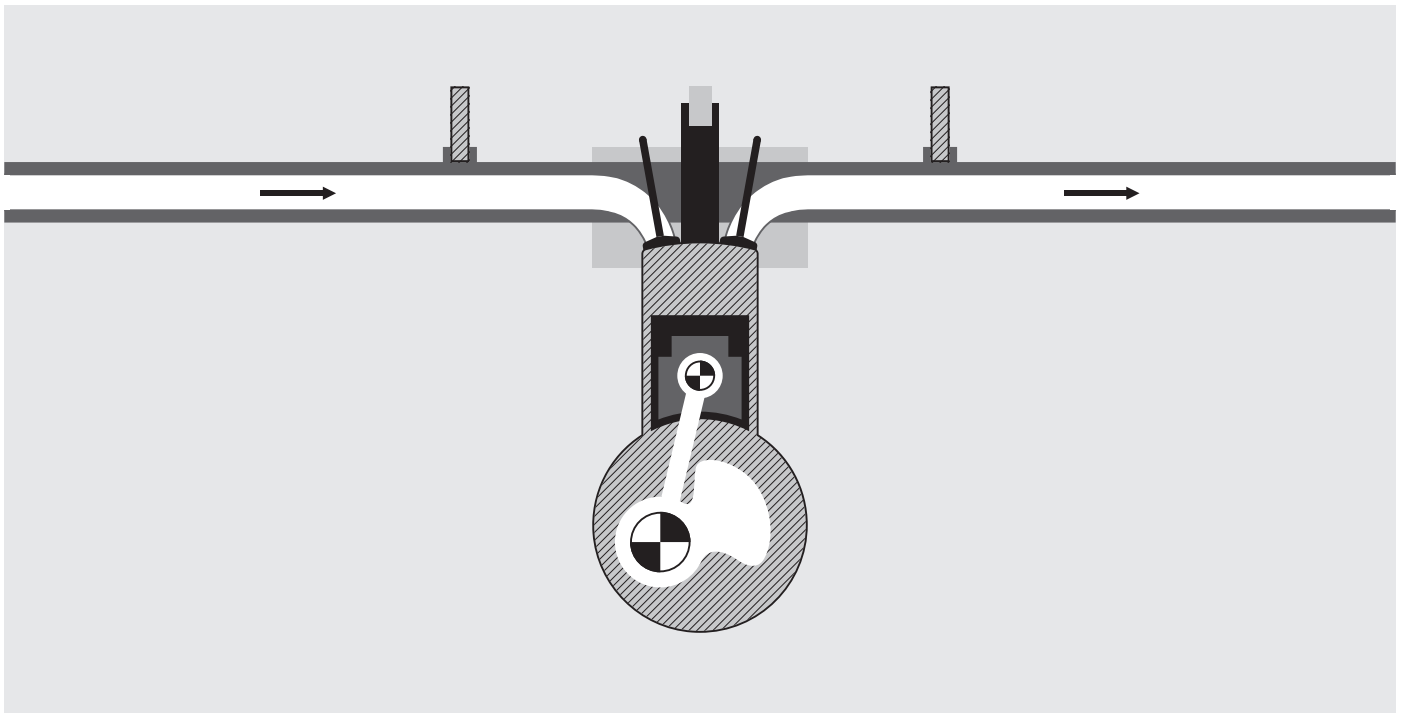

Possible positioning of the Kistler measurement sensors in the engine.

Fundamentals of indication technology

Engine technology has reached a level of complexity that cannot be managed without indication measurements. For the research, development and tuning of engines, it is the indication that lays the foundation for complying with the ever stricter emissions laws and for optimizing efficiency.

In principle, reciprocating internal combustion engines are heat engines: Through combustion, they convert the chemical energy bound in the fuel-air mixture largely into mechanical work and heat.

The goal of the engine developer is to extract as much mechanical work as possible from the conversion process, i.e., to maximize the efficiency. Of significance here are the level and temporal development of the cylinder pressure that acts on the pistons. This pressure curve is representative for the combustion and, thus, for the way in which energy is converted in the engine. The total accumulated mechanical work performed on the piston during a combustion cycle or stroke results from the pressure and the corresponding volume change of the combustion chamber.

Today, indication includes not only the actual combustion, but also gas exchange, injection system, ignition system and other sub-systems and parameters.

A better way to start

The most important source of information during indication is the profile of the cylinder pressure. Key characteristics here are both the signal level as well as the profile with reference to the position of top dead center (TDC) – the highest point that the piston passes through during its reciprocating movement in the cylinder.

Gas exchange analysis

With a gas exchange analysis, the filling of the individual cylinder is evaluated and optimized: The better the filling, the greater the achievable cylinder performance. But fuel consumption and emissions performance can also be improved with the help of the gas exchange analysis. This is important if the engine developer can influence the gas exchange with a variable valve train or can change the intake process with a variable intake manifold.

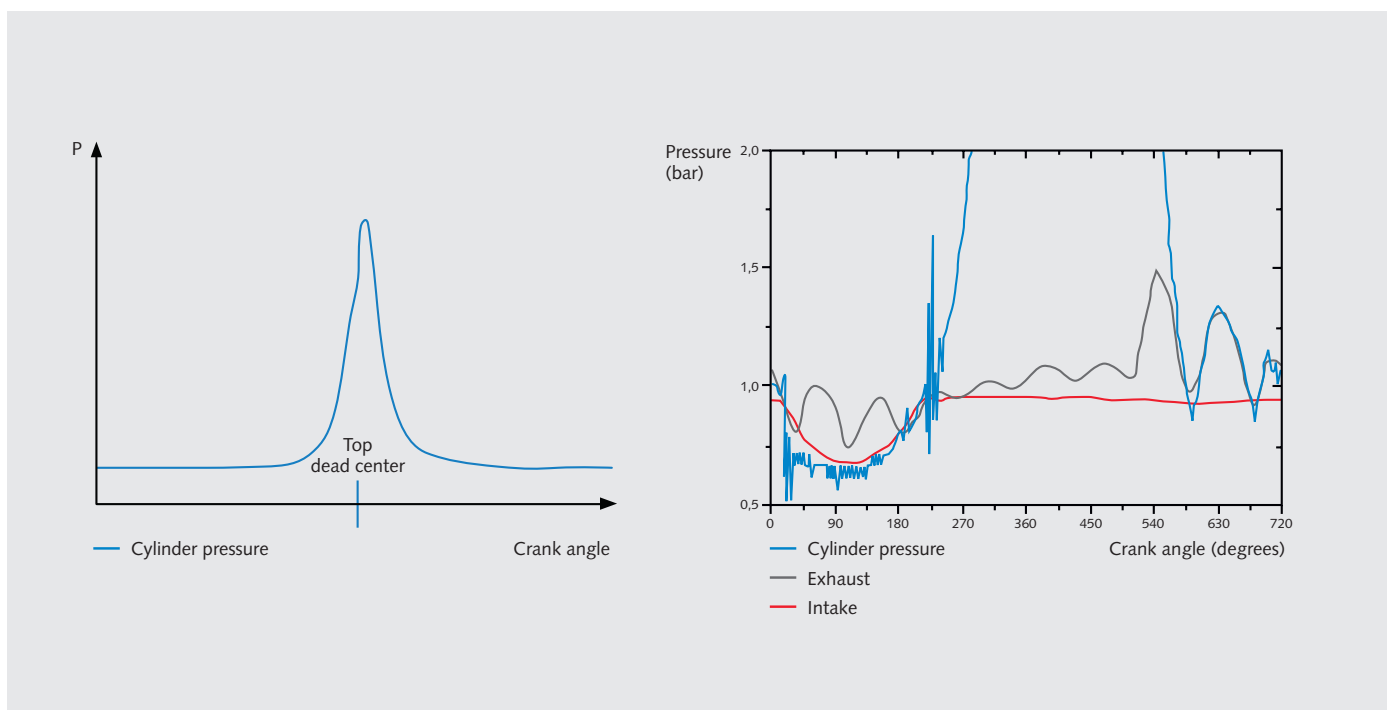

Cylinder pressure curve over cycle of 4-stroke diesel engine

Pressure courses intake manifold, cylinder, exhaust manifold

Kistler know-how

From the cylinder pressure signals, the following data and information – among others – are derived from cylinder pressure signals:

Derived data	Information content
Peak pressure	Mechanical engine load
Indicated mean effective pressure, complete 4-stroke cycle or only high-pressure component	Cylinder power, combustion stability (cyclical fluctuations), misfires, response behavior, friction losses
High-frequency vibration component	Knocking
Pressure gradient	Combustion noise
Crank angle position of the peak pressure, heat release rate, energy conversion points	Total efficiency, combustion efficiency, qualitative emission values, quality of the ignition system
Gas temperature	Qualitative emission values
Low-pressure component of the indicated mean effective pressure, pV diagram	Pumping losses
Combustion curve	Energy balance
Mass flow	Filling of the cylinder, residual gas content in the cylinder return flow, pumping losses
Ignition delay, calculated from ignition or injection timing and start of combustion	Carburetion, ignition timing

The whole world of engine indication – for exactly your application

Whether you want to improve the efficiency and comfort of a family car, or the performance and reliability of racecars – at Kistler you will always find the right solution for your needs.

Over the course of more than 50 years, we have developed an extensive line of combustion analysis technology that is tailored to a wide range of requirements. To help you to obtain meaningful measurements even faster, we offer you comprehensive systems by means of which you can combine indication on the test bench and in the vehicle.



Indication on the test bench

During engine indication on the test bench, the objective is to collect the most meaningful data with the best possible quality – and to do so with minimal time and cost.

For the exact measurement of the cylinder pressures, as well as of the intake and exhaust pressures, Kistler offers a wide range of solutions, e.g., water-cooled and uncooled piezoelectric cylinder pressure sensors, measuring spark plugs and glow plug adapters with integrated miniature pressure sensors, for various applications. Piezoresistive absolute pressure sensors for gas exchange and the injection pressure measurement with digital temperature compensation ensure maximum accuracy. With the SCP (Signal Conditioning Platform) from Kistler, you benefit from a powerful signal conditioning system. Thanks to the variety of interfaces, measurement results can easily be passed on to other test system measurement devices.

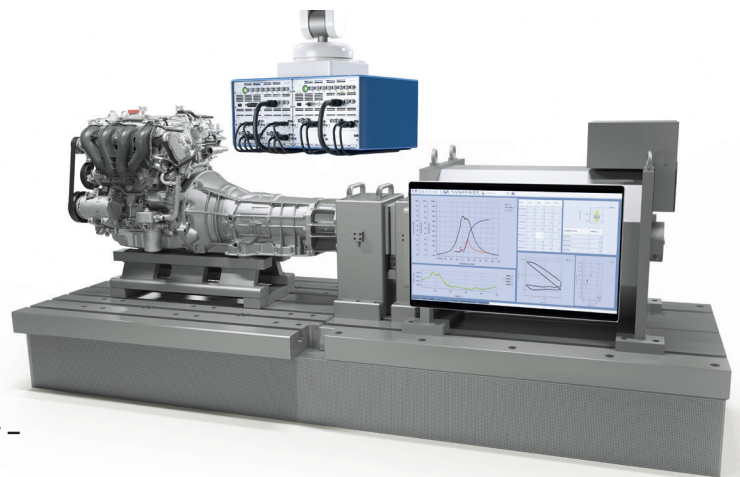

Advantages of Kistler cylinder pressure indication on the test bench:

- High-precision sensor solutions for a wide range of engine applications
- SCP modular signal conditioning system
- Quickly ready to measure, ready-to-use solutions
- PiezoSmart automatic sensor identification



Mobile indication

Accurate measurements become increasingly important when it comes to the optimization of internal combustion engine processes.

Physical boundary conditions that affect the properties of the engine can be represented only to a certain extent on the test bench. But developers need to act quickly and flexibly. Only with the help of a compatible and mobile indication system can they easily reconcile the test bench results through test drives within the scope of engine calibration or troubleshooting. For use in the vehicle, application engineers need a tool that supports them before, during and after the test drive with high functionality and computing power.

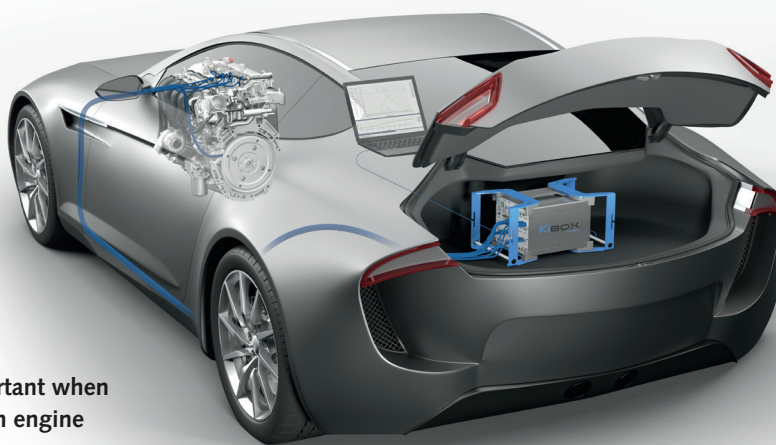

KiBox is the right solution here. It combines all hardware and software for data acquisition in a compact and easy-to-operate device. You can learn more about the Kibox and its advantages beginning on page 20.



On-board monitoring in motorsport

The demands placed on modern racecars are enormous and require many of monitoring and control sensors.

To ensure permanent operation at maximum performance, all systems must be perfectly designed and optimally integrated in the vehicle. Only in this way can maximum efficiency be achieved. Compact pressure sensors from Kistler ensure the highest signal quality and maximum reliability with minimum installation space. Custom, on-board solutions support engineers in the early detection of problems, in optimizing engine performance and in monitoring all types of systems.

Advantages of Kistler on-board solutions:

- Cylinder pressure measurement for maximum engine performance
- Real-time monitoring of performance-critical system
- Robust sensors for long-term use
- Optimized integration in the vehicle

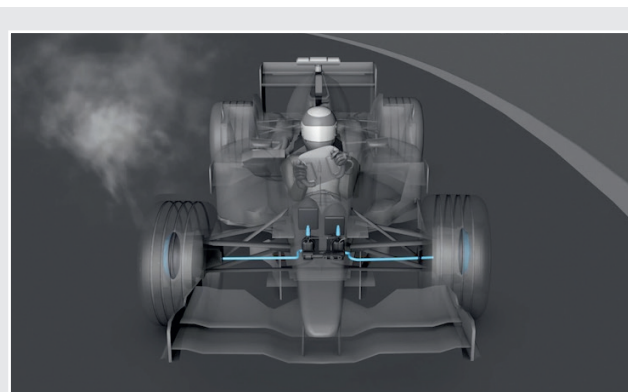

Experience now online: engine indication with Kistler
Experience the innovative Kistler solutions for engine indication in action. Our animation shows you the fast and effective path to successful engine development.
www.kistler.com/engine-motorsport

An integrated system for test bench and vehicle

Kistler sensors, cables, charge amplifiers and signal conditioning are part of an integrated complete system. The elements can be combined to form custom solutions for individual indication tasks.

Thanks to standardized interfaces, the signal processing is compatible with a wide range of test arrangements. PiezoSmart automatic sensor identification ensures the continuous data exchange between sensor and evaluation electronics. This forms the basis for simple as well as fast analysis and evaluation of your measurement data.



Measure

Only with reliable, precise measuring sensors can you obtain exact, reproducible measurement values. Kistler solutions are based on PiezoStar crystals and thereby provide the basis for optimized sensor concepts with maximum measurement accuracy.



Connect

The connection between sensor and charge amplifier is decisive. Pressure sensors output a low electric charge. Only the high quality of the connection – through high-impedance measurement cables – guarantees precise measurement results.

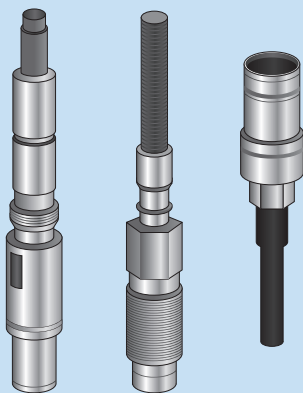

Sensors



Connection technology



Amplify & Condition

High-quality amplifiers convert the pressure curves to precisely scaled voltage signals and form the interface between sensor signal and measuring system in the proven SCP signal conditioning system. PiezoSmart automatic sensor identification enables the automatic parameterization of the measuring chain. In addition, the operating times of the sensor and the number of pressure cycles are recorded automatically. This guarantees you high flexibility, data quality and process reliability.

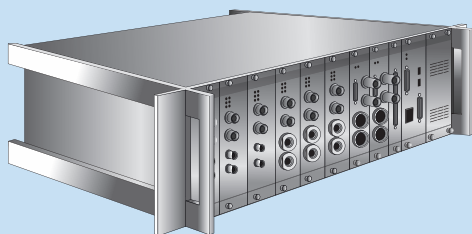

Signal conditioning platform



Acquire / Analyze

KiBox is a complete system for combustion analysis – from data acquisition to evaluation. It delivers detailed information on combustion quality in each individual cylinder and makes key engine development data available in real time – synchronized with other measurement data and ECU control variables. KiBox is designed for users who need information for controlling the injection valves, ignition and combustion. It can, however, also be used as an independent standard system for engine indication in the vehicle or on the test bench.

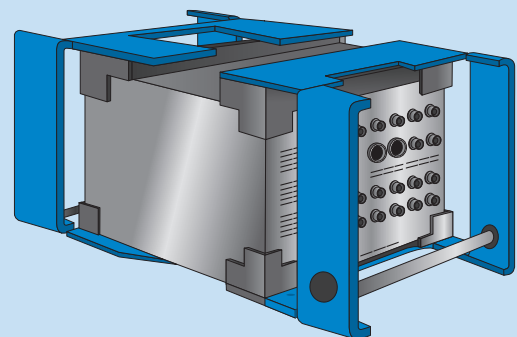

Systems

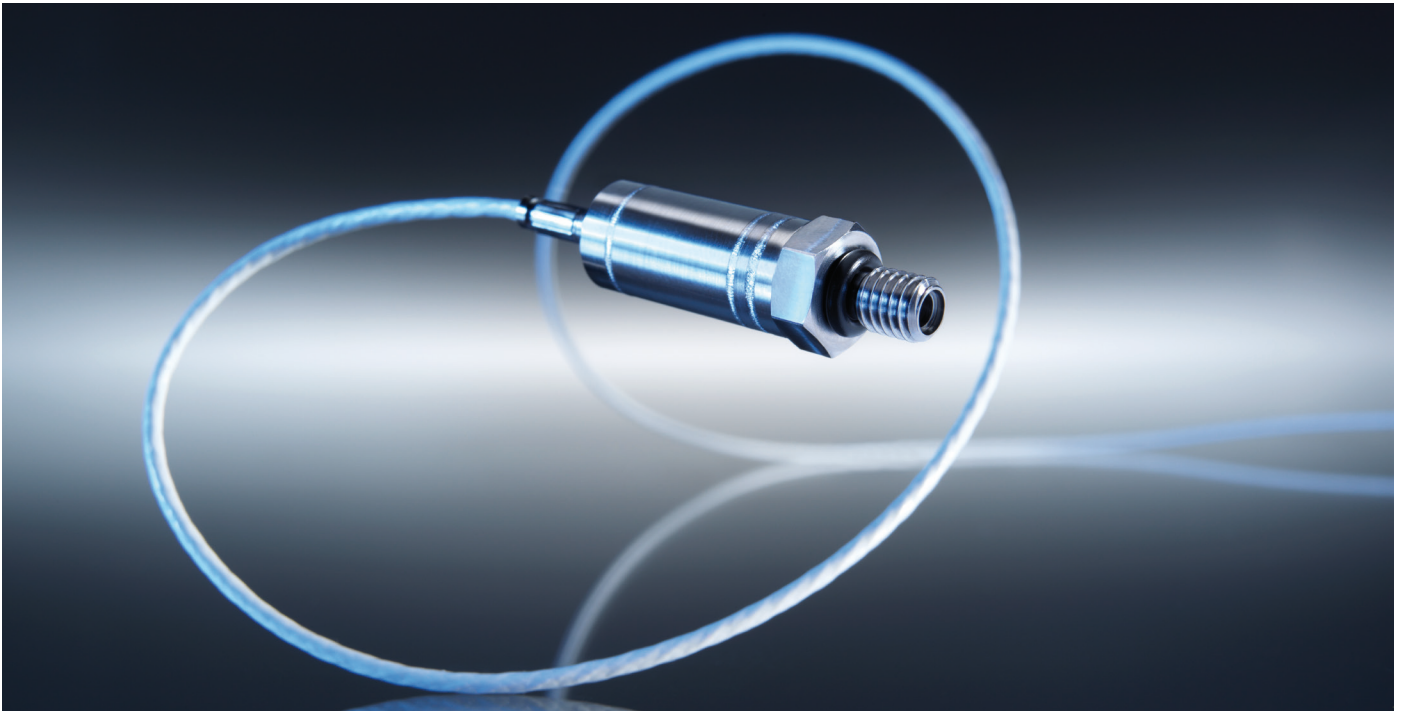

Kistler offers precise pressure sensors for every application.

High-precision measurement with the optimum sensor solution

Kistler offers you an extensive line of different pressure sensors for indication technology. This guarantees you optimum solutions for your specific tasks.

The right size

The Kistler pressure sensor portfolio spans from installation size M14 to miniature solutions in size M5. The compact sensors can also be ideally positioned in tight spaces.

Flexible design

The modular sensor design and the wide range of different adapter, cable and plug combinations makes the systems highly flexible.

Maximum accuracy

If low-pressure indication is the focus of your research and development, maximum accuracy is required. You can be certain that Kistler sensors always meet this requirement. Through the use of cooled switching adapters, you can increase the accuracy even further.

Custom special versions

Should it be determined that the best sensor for your measurement does not yet exist, then we will optimize our products for your specific requirements or will develop and produce a completely new solution for you.

The advantages of Kistler pressure sensors:

- Highly precise and reliable
- Long service life
- Versatile and adaptable

Customization for crystal clear results

The production of Kistler pressure sensors has a great deal in common with watch making in a precision workshop. The production and micrometer-precise assembly of the individual parts that measure just millimeters require delicate handwork. Quality has top priority here.

PiezoStar crystals – custom-grown for indication

At the heart of the Kistler pressure sensor is a measurement element made of quartz or crystal. Extreme ambient conditions place high demands on the material. By growing its own crystals, Kistler is able to produce measurement elements with tailor-made properties for the various applications. These crystals, referred to as PiezoStar crystals, are characterized by high sensitivity and temperature stability – for high-precision measurement results.

The technologies

Kistler employs two technologies for pressure measurement: Piezoelectric miniature pressure sensors measure cylinder pressures with extremely high precision. This is the basis for the thermodynamic assessment of the combustion process. Also unique are piezoresistive pressure sensors for precise pressure measurement in the inlet and exhaust port.

Piezoelectric pressure sensors

The piezoelectric effect is based on the electric charging of surfaces of certain crystals (including quartz) when subjected to mechanical load. This electric charge is exactly proportional to the force acting on the crystal. It is measured in units of picocoulomb. Piezoelectric sensors are active sensors. They can therefore only measure quasi-statically, not truly statically. They are very well suited for dynamic measurement applications. Piezoelectric pressure sensors are used wherever rapidly changing pressures at temperatures of up to 400 °C must be measured as accurately as possible.

Piezoresistive pressure sensors

The piezoresistive principle is based on a semiconductor effect: When subjected to mechanical tension, semiconductors change their electric resistance. Kistler's piezoresistive sensors measure static pressures in gases and liquids. Even under the most adverse conditions, the results are precise and reproducible.

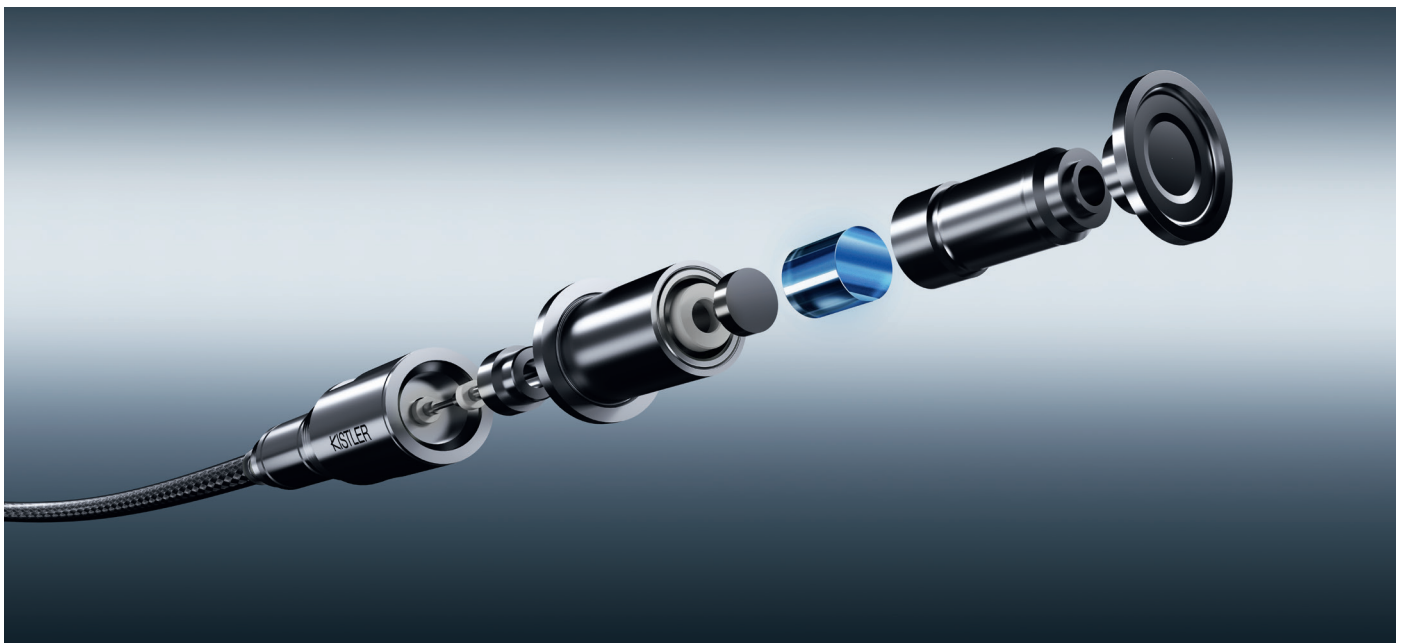

At the heart of the Kistler sensor technology is the crystal.



The right position – with and without additional bore

The correct positioning of the pressure sensor is decisive for the quality of the measurement and the service life. With the correct indicating bore, the thermal shock is reduced to a minimum.

The optimum indicating bore

When installing the sensor, it is very important that the specifications for tolerance and surface quality of the indicating bore and for the tightening torques of the sensors be strictly adhered to. Kistler offers you an extensive range of tools with which you can produce a proper indicating bore with little effort: from the bore and the thread to the actual installation of the sensor to reworking the sealing surfaces.

No space for a bore

If a measurement without separate indicating bore is desired in a gasoline engine, Kistler supplies you with the appropriate solution with the measuring spark plug. This is simply exchanged with the spark plug installed in the engine. In its core, the measuring spark plug is equipped with the world's smallest piezoelectric, high-temperature cylinder pressure sensor and delivers precise measuring results. For diesel engines, the corresponding glow plug adapter is available.

Front sealing

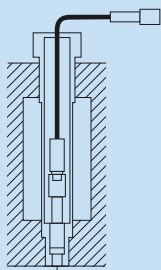

with mounting sleeves

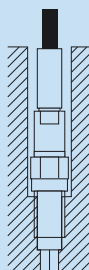

direct

Shoulder sealing

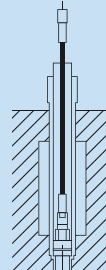

with mounting sleeves

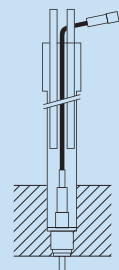

direct

Front-sealing installation:

With front-sealing installation in the cylinder head, the best possible heat dissipation is achieved.

Shoulder-sealing installation:

With shoulder-sealing installation, minimum stress is transferred to the diaphragm. Installation without access bore ensures maximum signal quality.

Installation with mounting sleeve:

The installation location in the cylinder head of the combustion engine is often only accessible via an oil or coolant duct. To seal the sensor against liquids, an installation sleeve must be used.

Direct mounting:

Direct mounting requires the smallest space. A number of points must, however, be observed to avoid damaging the cylinder head. Mounting and dismounting the sensor numerous times poses the risk of increased wear to the sealing elements.

Perfect connection for the best data transmission

The key to smooth data transmission is the choice of connecting cable.

High insulation against electrical drift

The electrical connection between piezoelectric sensor and charge amplifier must have a high level of electrical insulation (at least $10^{13} \Omega$). Electrical drift of the measurement signal will otherwise occur. Our specially coated coax- and triax-cables have one conductor, which is insulated with Teflon or Kapton. The same requirements apply for our plug and receptacle connectors. Only very small currents flow in the cables. To minimize susceptibility to electrical interference, they should be kept as short as possible.

Triboelectric effect

Movement of the cables produces minimal charges on the conductor surfaces (triboelectric effect) that can falsify the measurement. This is prevented with the help of a special graphite intermediate layer. Typical values of the triboelectricity of our special cables when subjected to strong vibrations are less than 1 pC. Nevertheless, the cables should still be laid vibration-free. This is particularly important in an engine measurement environment.

The following cable materials are available for selection:

PFA

The cable covering made of perfluoroalkoxy alkanes (PFA) exhibits good strength, even at very high temperatures, outstanding thermal stability as well excellent chemical resistance. When using the cables without protective covering made of metal mesh, ensure that they are not subjected to any mechanical load, e.g., due to friction.

PFA/metal

These cables are reinforced with a flexible mesh made of steel or stainless steel to provide additional protection against mechanical loads, such as friction caused by vibration. Aside from this, the cables have the same design as the PFA version with a covering made of the chemical- and temperature-resistant perfluoroalkoxy alkane.

FPM

The FPM material is characterized by high thermal and chemical resistance – especially against hydrocarbons. The cables equipped with a liquid tight connector are therefore extremely robust and can withstand the influence of oils and fuels.

Teflon and Kapton are registered trademarks of the Du Pont Corporation.



Automatic sensor identification with PiezoSmart

Detailed planning, extensive measuring chain parameterization and precise measuring point assignment – just preparing for engine indication is extremely time consuming. The preparation of the required documentation and the corresponding procedures are labour intensive and prone to errors.

PiezoSmart automatic sensor identification in combination with the SCP (Signal Conditioning Platform) reduces your preparatory work, enables more flexibility and thereby increases the process reliability. PiezoSmart is an active system for the automatic identification of individual pressure sensors. The automatic parameterization of the measuring chain according to the "Plug & Measure" principle reduces the risk of errors and the set-up time. Additional functions guarantee the continuous quality assurance of the indication data.

Clear assignment of sensor data

The heart of PiezoSmart is an "electronic data sheet", the so-called Transducer Electronic Data Sheet (TEDS). This is a chip in the amplifier-side connector of the sensor cable on which the sensor data is stored. The pressure sensor and the connecting cable with TEDS form a physical, easy-to-mount unit. The unique and reliable assignment of the sensor data is thereby ensured in the test environment.

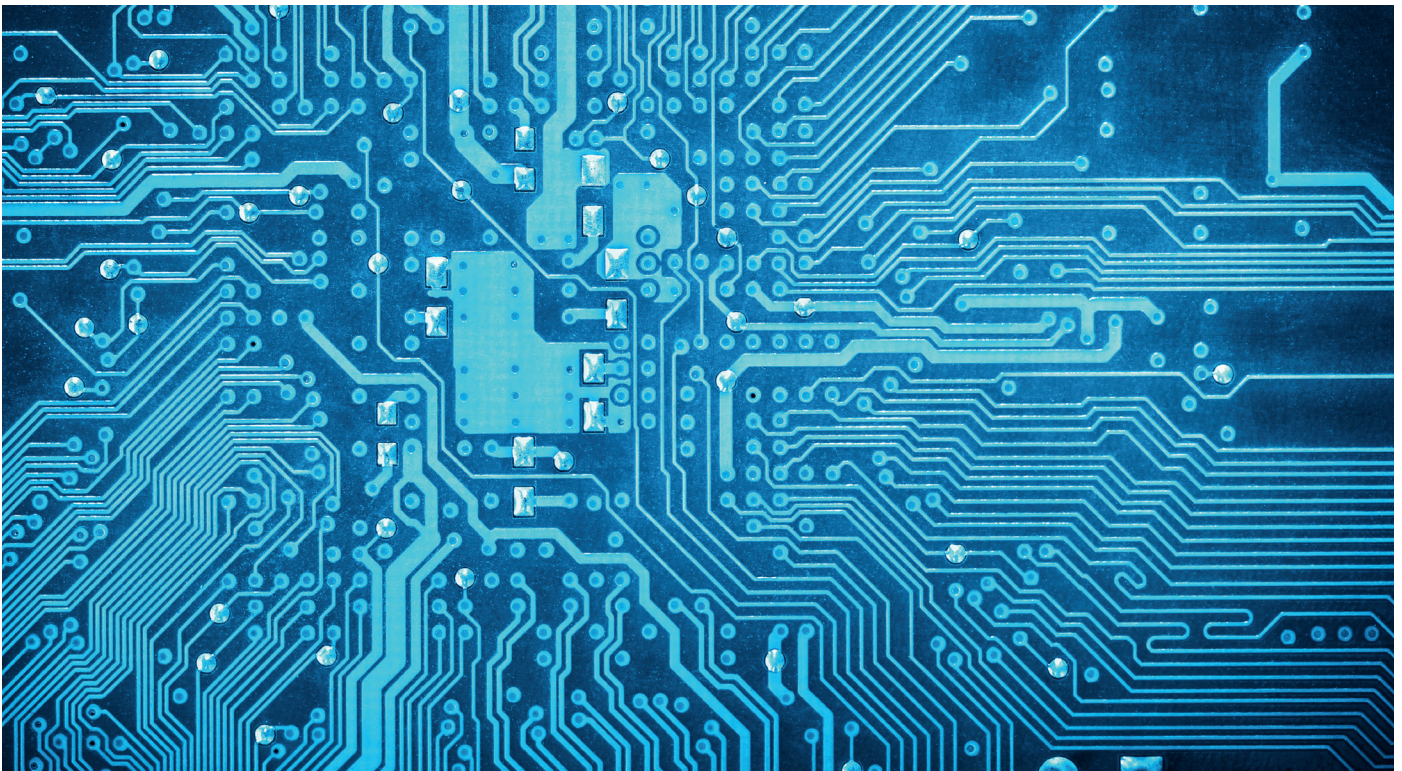

"Plug & Measure" thanks to smart chip technology.

All calibration data under control

The TEDS contains the serial number, the initial calibration values and the current calibration values of the sensor as well as additional manufacturer and identification data. Monitoring of the sensor-specific initial and recalibration values enables the early detection of sensor anomalies. This, in turn, helps to avoid test failures and data losses. The data in TEDS has password and write permissions for various hierarchy levels. As a result, any necessary recalibrations of the sensor or the replacement of defective sensors and cables is also possible for you as the user.

Autonomous operation

Because the sensor data is stored decentrally, PiezoSmart makes possible the autonomous operation of sensor and measuring chain. The system is ready for use at any time, since an upstream database is not absolutely necessary.

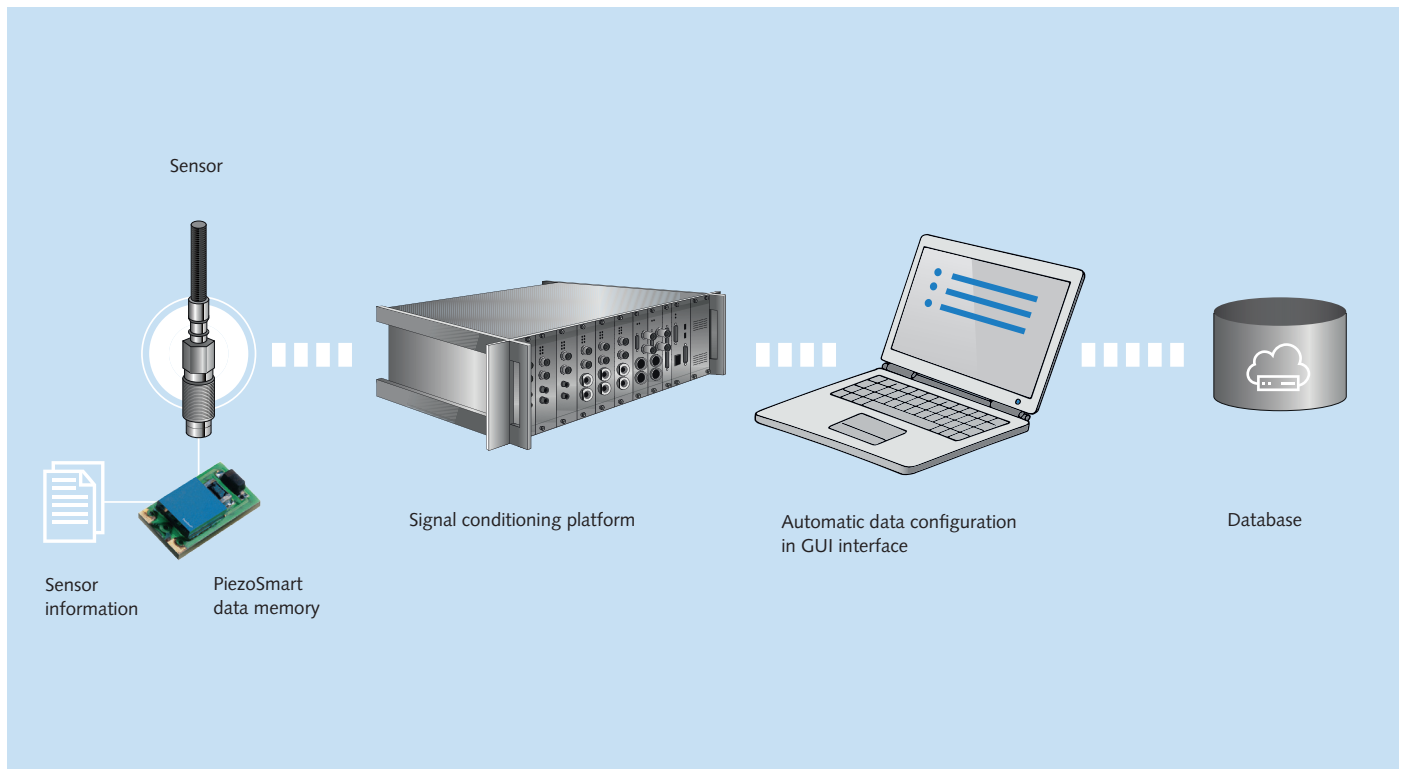

Operating principle of PiezoSmart sensors

Intuitive operation with the graphical user interface

Via the graphical user interface, you can intuitively check and parameterize all SCP parameters as well as the used measurement modules.

The user interface provides an overview of the key data, such as measurement module configurations, sensor data and operating time – for simple and fast data processing. Changes can easily be made on a single screen. An export function converts the data to different formats for documenting all measurement settings. Cylinder peak pressure histograms can be created at the click of the mouse for each sensor, enabling you as the user to immediately view the sensor load and identify other irregularities.

Protected against manipulation

To protect the SCP settings from unintentional manipulation, two SCP states are available. In the "Operation" state, only the measurement states of the piezoelectric amplifiers can be changed. Although all other parameters are displayed, they cannot be changed. In the "Configuration" state, all parameters of the SCP are displayed and can be changed.

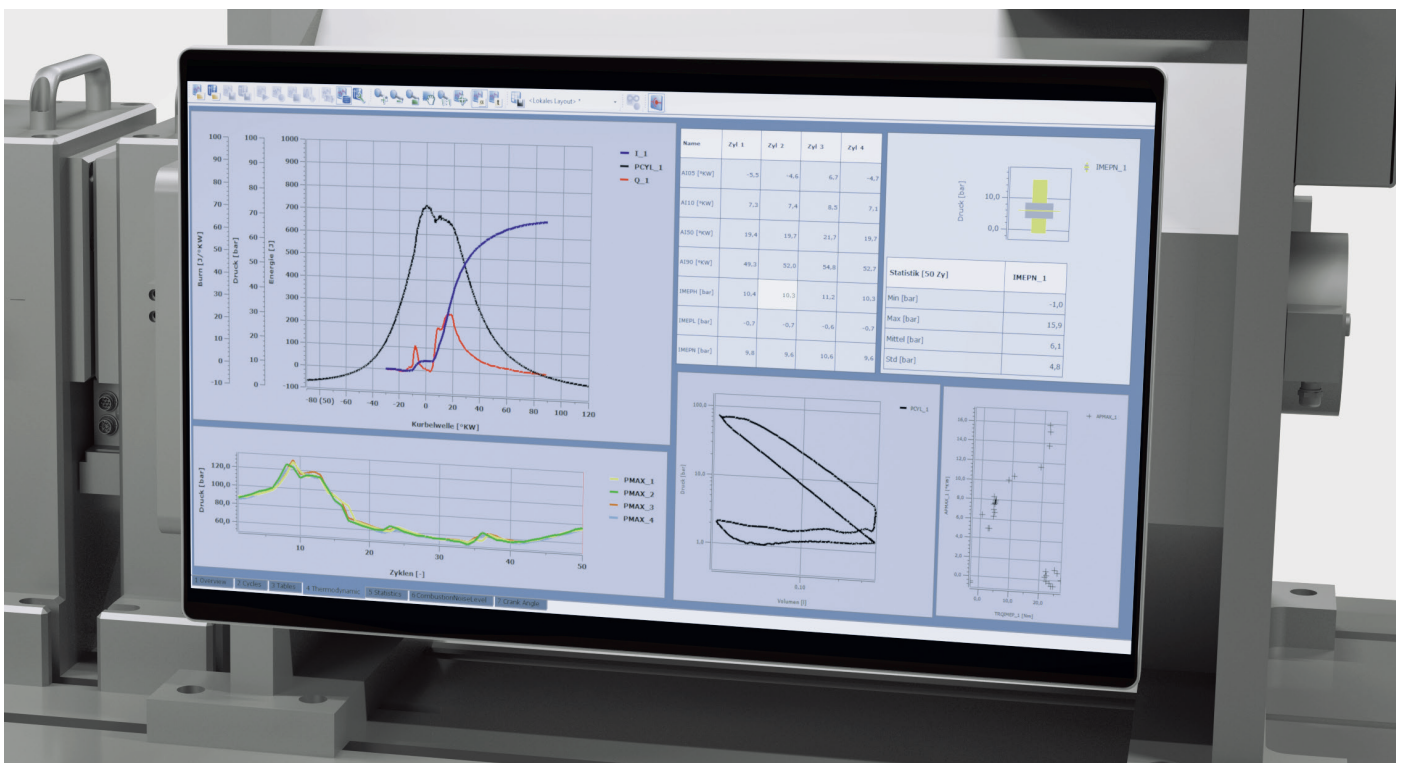

The Kistler user interface allows users to work very efficient.

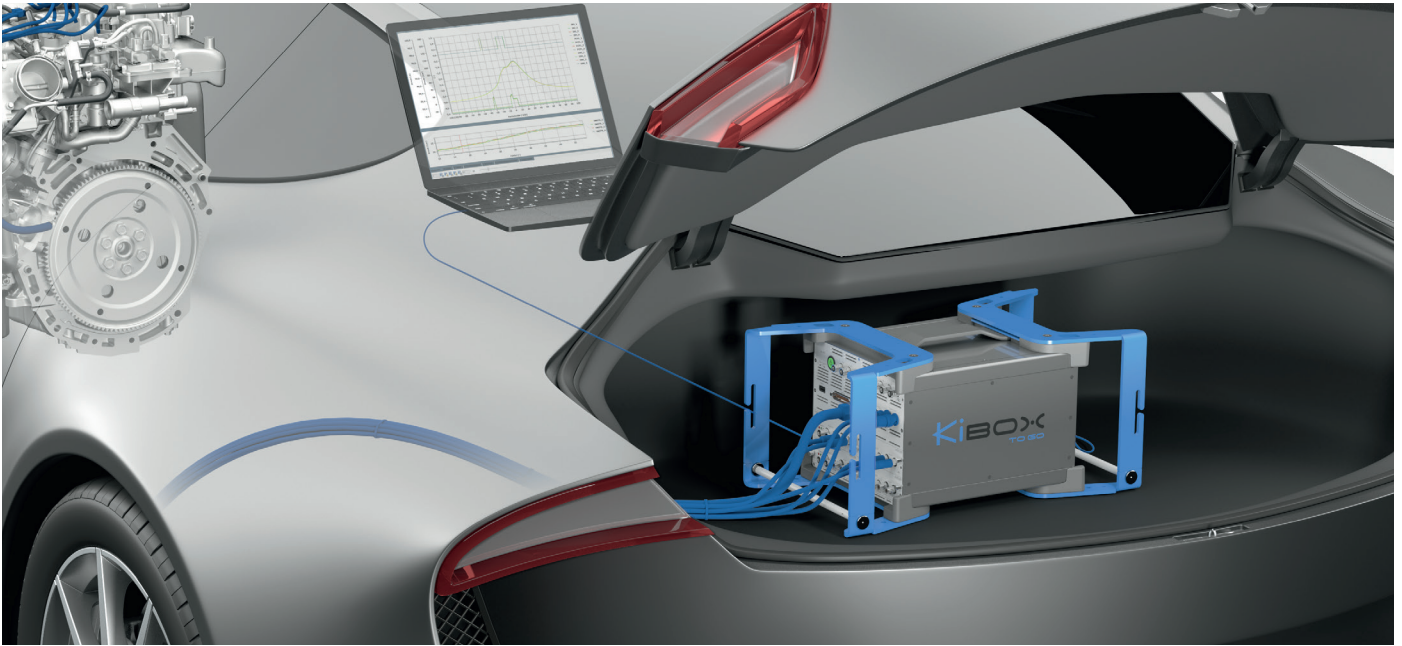

The KiBox – two areas of application, one reliable measurement result

The challenge of engine indication

Whether on the road or on the test bench – during engine indication, you need highly precise results in every area. Developers want to quickly and easily reconcile their extensive data from the engine test bench with in-vehicle tests. The requirement is a tool that supports in all phases of development with high functionality and processing power. Only with a comprehensive and flexible solution are you guaranteed to always receive valid and comparable results.

Double the advantage with KiBox

The compact KiBox is a complete system for combustion analysis – for mobile use and for the test bench. It delivers detailed information on combustion quality in each individual cylinder and makes key engine development data available in real time – synchronized with other measurement data and ECU control variables. Standardized interfaces, powerful PC technology and the proven SCP amplifier modules make the KiBox a future-proof and easy-to-use tool that quickly provides you with high quality data.

Advantages of the flexible KiBox:

- High reliability
- Qualitative measurement results
- Increase in test efficiency
- Promotion and protection of individual know-how

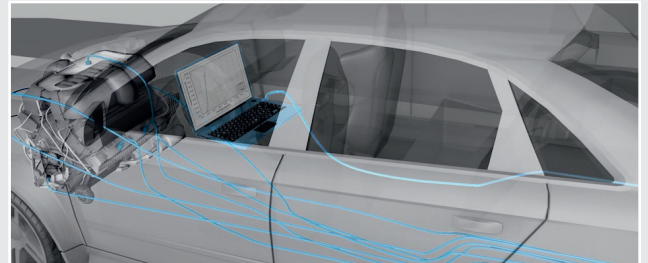

Experience now online: engine indication with Kistler

Experience the innovative Kistler solutions for engine indication in action. Our animation shows you the fast and effective path to successful engine development.

www.kistler.com/engine-mobile



Balanced measuring chain

To be practical, a combustion analysis measurement must not significantly influence engine operation and must also deliver high-quality measurement results. For this purpose, all components of the measuring chain are to be optimized both individually as well as in their interaction with one another. Kistler supplies the right products for each link of this chain. The Kistler KiBox is part of an optimum complete solution.

Intuitive use

A simple and well-structured operating software program, the "KiBox Cockpit", facilitates the organization, evaluation and visualization of the measurement data. The KiBox Cockpit is integrated in the familiar work environment, e.g., the ECU and test bed automation system (AuSys).

Maximum data quality

The basis for a meaningful measurement campaign during indication in transient engine operation is a high data quality. KiBox assures this with innovative signal processing that completely eliminates the occurrence of aliasing effects.

Characteristic values directly from the KiBox

- Knocking
- Peak pressure (mechanical load) and its angular position
- Indicated mean effective pressure (total, high-pressure and gas-exchange component)
- Heat release rate
- Energy conversion points and burn duration
- Ignition timing
- Injection timing
- Rotational speed (averaged and high resolution)
- Maximum pressure rise and its angular position
- Combustion noise (frequency analysis)
- Statistical evaluation of all characteristic values
- User-defined calculation (user formula)

*Real-time calculation on the hardware



Our experts can provide you with advice on all matters related to engine indication.

Service tailored to your success

Our extensive engine indication program also includes a diverse range of services. This helps you work more effectively and more efficiently with our solutions day after day and year after year.

Application consulting

Kistler application technology can provide you with advice on all matters related to engine indication – for maximum accuracy and a long service life of the sensors.

Calibration service

Our Kistler calibration service operates in strict compliance with all relevant quality assurance and documentation guidelines. On request, we can perform the calibration on-site in a time- and cost-effective manner.

Custom special versions

If the optimum sensor does not yet exist for your measurement, we will develop an individual solution together with you which, thanks to modular design, can generally be produced at a reasonable expense.

Retrofitting with PiezoSmart sensor identification

The modular design of our sensors allows the PiezoSmart sensor identification to be retrofitted in your existing structures – by us or your own personnel.

Kistler services at a glance:

- Customized sensor versions
- Retrofitting with PiezoSmart sensor identification
- Calibration service in-house or at the customer's location
- Products for calibrating sensors
- Customer seminars for training and continuing education
- Installation and process instructions for sensors
- Literature and information brochures for specific applications

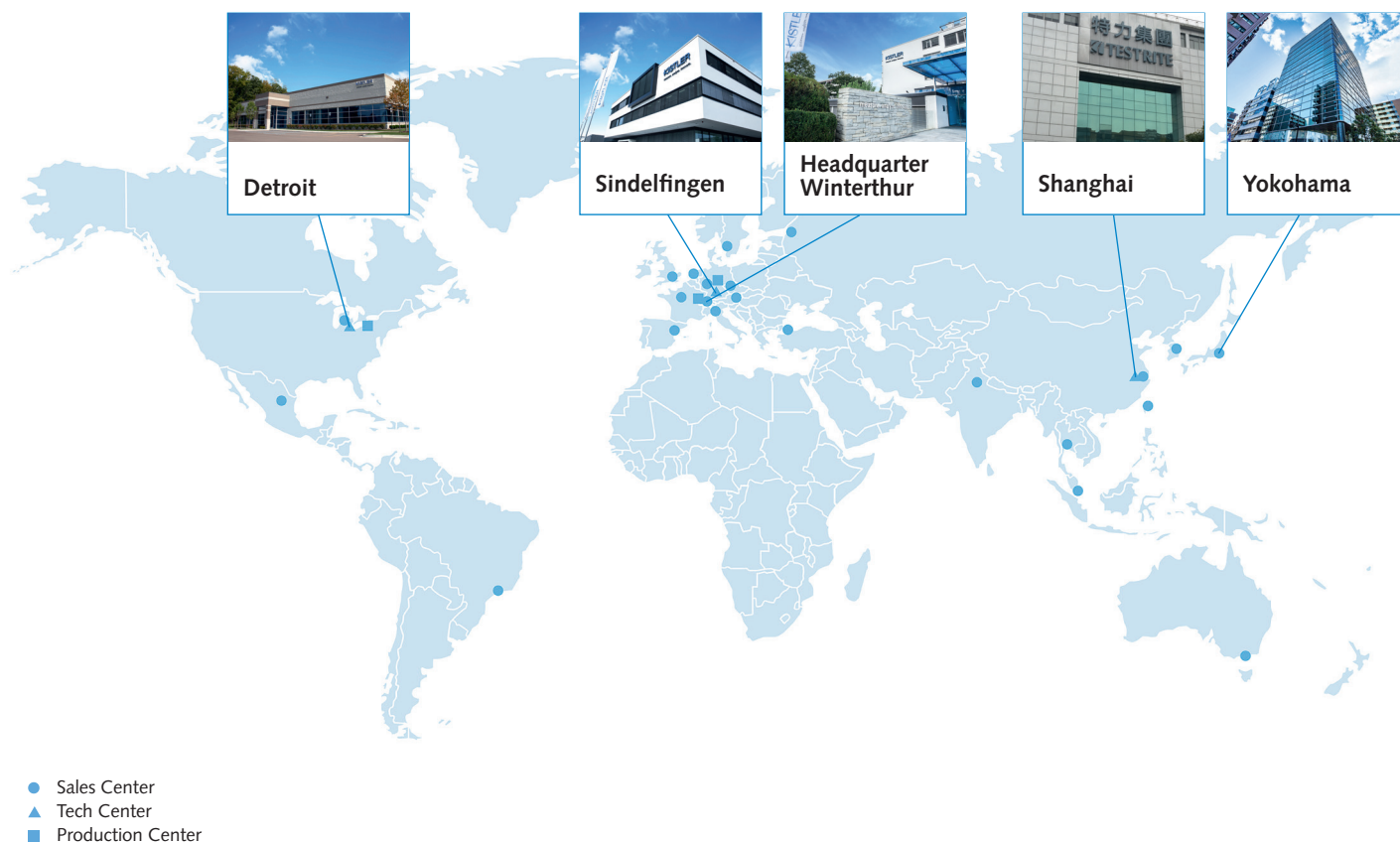

At our customers' service across the globe

Wherever vehicle and engine tests are carried out, Kistler is on hand to offer sensors and systems – backed up by a host of services that range from professional advice and support to calibration and speedy deliveries of spare parts across the globe. To offer even better technical support, Kistler is setting up Tech Centers throughout the world – delivering exactly the service that our customers expect so they can optimize their testing activities.

Find out more about our applications:
www.kistler.com/applications

Kistler Group
 Eulachstrasse 22
 8408 Winterthur
 Switzerland
 Tel. +41 52 224 11 11

Kistler Group products are protected by various intellectual property rights. For more details visit www.kistler.com. The Kistler Group includes Kistler Holding AG and all its subsidiaries in Europe, Asia, the Americas and Australia.

Find your local contact on
www.kistler.com

KISTLER
 measure. analyze. innovate.