

KISTLER

measure. analyze. innovate.



**Test & Measurement
acceleration, acoustic
emission and dynamic force**

Measuring equipment for demanding T&M applications



Absolute Attention for tomorrow's world

Kistler develops solutions for challenges in measurement technology with a portfolio that comprises sensors, electronics, systems and services. We push the frontiers of physics in fields such as emission reduction, quality control, mobility and vehicle safety: our products deliver top performance to meet the standards of tomorrow's world, providing the ideal basis for Industry 4.0. This is how we pave the way for innovation and growth – for our customers, and with our customers.

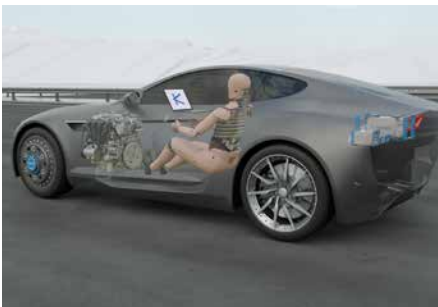

Kistler: the byword for advances in engine monitoring, vehicle safety and vehicle dynamics. Our products deliver data that plays a key part in developing efficient vehicles for tomorrow's world.



Measurement technology from Kistler ensures top performance in sport diagnostics, traffic data acquisition, cutting force analysis and many other applications where absolutely reliable measurements are required despite extreme conditions.



By supporting all the stages in networked, digitalized production, Kistler's systems maximize process efficiency and cost-effectiveness in the smart factories of the next generation.

Contents

Kistler measures acceleration	4	Acoustic emissions	44
Structural testing	4	Acoustic emission sensors/conditioning	44
Aerospace and military	4	High temperature accelerometers	45
Automotive/transportation	5	Electronics	46
Civil engineering	5	IEPE sensor power supply	46
Environmental stress screening	5	MEMS sensor power supply	48
Kistler piezoelectric sensor technology solutions	6	Dual-mode charge amplifiers	49
MEMS capacitive sensor solutions	6	In-line IEPE signal conditioning	50
Charge output sensor solutions	6	Calibration and test equipment	51
Voltage (IEPE) sensor solutions	6	IEPE/voltage and charge output sensors	51
Kistler calibration	7	Reference shakers, insulation tester and HSU-nielsen test kit	52
A new dimension in sensor technology	8	Accessories	53
PiezoStar IEPE accelerometers	8	Mounting	53
PiezoStar IEPE accelerometer applications	9	Cables	58
Product overview		Connector adapters	60
DC & charge accelerometers	10	Piezoelectric theory	61
Single-axis IEPE accelerometers	12	Piezoelectric effect	61
single-axis IEPE accelerometers	14	Applications of piezoelectric instruments	61
triaxial IEPE accelerometers	16	Piezoelectric sensors (Quartz-based)	61
others	18	Dynamic behavior of sensors	62
Static and low frequency vibration	20	Charge amplifiers	62
K-Beam MEMS capacitive, low frequency accelerometers – single-axis	20	Low impedance piezoelectric sensors	63
K-Beam MEMS capacitive, low frequency accelerometers – triaxial	21	Capacitive accelerometer theory	64
General vibration	22	Glossary	68
Charge accelerometers – single-axis	22	Kistler, your partner for innovation	70
Charge accelerometers – triaxial	23		
IEPE accelerometers – single-axis	24		
IEPE accelerometers – triaxial	33		
Shock sensors	39		
IEPE accelerometers – single-axis	39		
Modal analysis – force	40		
Impedance head and charge force sensors	40		
IEPE force sensors	41		
Modal analysis	42		
IEPE Impulse hammers	42		
Rotational accelerometers	43		



Kistler measures acceleration

Accelerometers are used in every avenue of the dynamic test environment and Kistler has developed families of products covering this expansive range of applications. From ultra-low motions encountered in wafer fabrication technology to shock spectra reconstruction experienced in pyrotechnic separation event studies and everywhere in between, an optimal sensor solution is available. Static events are captured with the K-Beam static and low frequency product offerings. Very high frequency activity is routinely measured using any of several miniature piezo-electric single-axis or triaxial types. Many sensing technologies including piezoceramic, natural quartz and variable capacitance approaches have been extensively explored and are employed as needed to accommodate the demands of the application.

Structural testing

Mechanical devices, assemblies, and constructions of all types are investigated using accelerometers to measure their dynamic response when subjected to a known input. The deformation pattern, when the specimen experiences resonance, can be computed from the measured data.

Known as “Experimental Modal Analysis” (EMA), this field of study often uses a member of the PiezoBeam family or Ceramic Shear family where their general characteristics have been adapted to accommodate most requirements of common tests. Typical high-lighted features include high output from a low-weight sensor, ground isolated, and an inexpensive package providing an economical solution for large channel count application.

Aerospace and military

Very demanding application are encountered in the military and aerospace industry where any error may present a life-threatening situation. This category also covers a tremendous range of applications and nearly all accelerometer product offerings have been used in these important investigations.

Flutter testing, rocket launch pad dynamics, aircraft EMA, ammunition investigations, helicopter rotor reactions, etc., are a few of the common measurements performed.

Kistler measures acceleration

Remarkable lifetime under any condition



Space quality measurements are routine

Precise, ultra-low frequency, measurements are common using a K-Beam solution



Aviation Ground Testing of the Beluga Aircraft using Kistler Custom Solutions

Modal studies easily accomplished using an array of inexpensive accelerometers



Harsh environments present negligible concern when using K-Shear accelerometers

Tilt and comfort controlled using K-Beam feedback

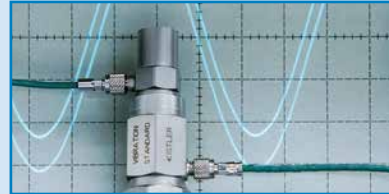

Onsite or factory calibration solutions available

Automotive/transportation

Ride quality has been receiving tremendous attention in recent years. New vehicle designs are presenting less noise to the occupants and the subtle details of the intricacies of road/wheel interaction, bump & jar response, and the overall feel of the ride are important to even the common customer. The K-Beam family covers the low to mid frequency range of many investigations and the many piezoelectric offerings extend into the higher frequency areas of interest.

Civil engineering

Very low frequency activity is of interest when studying extremely large structures, such as bridges, buildings or dams. These specimens require DC capable accelerometers since most dynamic activity is in the very low frequency realm often in the range of a few hertz. The K-Beam product family is commonly used to measure vibration and acceleration in this arena.

Environmental stress screening

Computer components, automotive electronics, and miniature mechanical assemblies are often exposed to an aggressive life test or actual functional tests under extreme environmental conditions. This may involve multiple impact drop testing or wide range thermal cycling and many of the K-Shear product offerings have been tailored to survive and perform extremely well even under incredibly abusive conditions. The M5- and M8- suffixes provide extreme high and low temperature capabilities respectively while the shear shock Types 8742 and 8743 survive after numerous exposure to high-level cyclic inputs.

Kistler piezoelectric sensor technology solutions

Most Kistler sensors incorporate a quartz element, which is sensitive to either compressive or shear loads. The sensor is connected to an electronic device for converting the charge signal into a voltage signal proportional to the mechanical force. The conversion is made either by means of a separate charge amplifier or an impedance converter with coupler, typically integrated into the sensor. Kistler relies mainly on the "Piezoelectric Theory" (see definition on pages 61 ... 65) for measuring dynamic forces in assembly and testing.

Kistler offers a variety of sensor technologies: Capacitive, Charge, and Voltage (IEPE). Examples of these sensor types are provided below. Each offers unique application solutions applications tailored to your specific needs. For a detailed explanation of these Kistler sensor types, please refer to pages 61 ... 65.



MEMS capacitive sensor solutions

Type 8316A, single-axis MEMS capacitive accelerometer



Type 8396A, triaxial MEMS capacitive accelerometer



Advantages

of Kistler capacitive accelerometers:

- Measures DC
- Built-in low-pass filters
- Repeatable measurements

Applications:

- Low frequency vibrations
- Ride quality
- Aerospace structural analysis
- Orientation

Charge output sensor solutions

Types 8202A10/8203A50, single-axis charge output accelerometers



Type 8248A3, triaxial Charge output accelerometer



Advantages

of Kistler charge accelerometers:

- Adjustable time constant
- Adjustable full-scale output
- Can apply filters with charge amp
- Wide temperature range

Applications:

- Shock
- High amplitude vibrations
- Vehicle or environmental testing
- High temperature

Voltage (IEPE) sensor solutions

Type 8774B, single-axis Voltage mode (IEPE) accelerometer



Type 8763B, triaxial Voltage mode (IEPE) accelerometer



Advantages

of Kistler IEPE accelerometers:

- Built-in charge-to-voltage converter
- Ideal for dynamic measurements
- Does not require low noise cables
- Long cable length
- TEDS option available

Applications:

- Vibrations
- Vehicle or environmental testing
- Modal analysis



Kistler calibration

Kistler accelerometers are calibrated in the factory and delivered with a calibration certificate. The reference sensors are cross-referenced to national standards. Kistler operates a NIST traceable calibration center and the calibration laboratory No. 049 of the Swiss Calibration Service for the measurands: force, pressure, acceleration and electric charge.

Kistler and some of its group companies offer a recalibration service and the company records in its archives the details of when and how often a particular sensor was calibrated.

Kistler offers an onsite service for recalibrating built-in sensors, thereby minimizing downtimes. In addition, Kistler offers a wide range of instruments for use in calibration laboratories.

Our calibration service receives the highest marks. The calibration of your instruments, manufactured by Kistler or someone else, is performed with quality care and precision. Our standard prompt service is exceptional. Kistler operates numerous calibration laboratories accredited to ISO/IEC 17025.

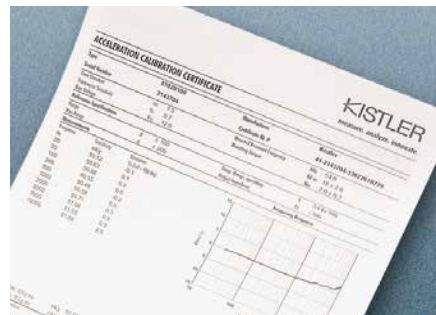

National referenced calibration services available

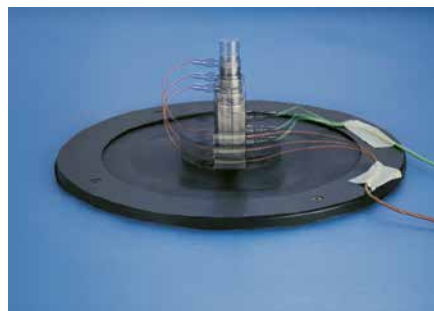

Onsite, traceable calibration systems

A new dimension in sensor technology

PiezoStar IEPE accelerometers

For more than 40 years, Kistler has been developing and manufacturing piezoelectric sensors that are used to measure pressure, force and acceleration under extreme conditions. Presently, sensor elements are increasingly manufactured from new types of crystals.

Miniaturization and temperature stability

Market trends toward miniaturization and stability at higher operating temperatures have resulted in a need for new types of crystals. Resultingly, research has been conducted for over ten years in cooperation with universities and institutes throughout the world to investigate new crystal compounds and develop growing processes. The fruit of this research is the PiezoStar family of crystals, which exhibit unique performance to improve the data quality for physical measurements. Marking 10 years of in-house crystal production is a third expansion of crystal manufacturing capacity. This material is the key to improved sensor elements for pressure, force and acceleration sensors extending higher accuracy and providing better sensitivity at higher working temperatures.

Kistler has optimized the PiezoStar crystal elements for use in piezoelectric and IEPE (Integrated Electronics Piezoelectric) sensors, thus strengthening its technological edge in sensor technology. PiezoStar crystals currently reside within many Kistler sensors. In particular, Kistler PiezoStar (IEPE) accelerometers use shear cut seismic elements in combination with high temperature internal hybrid microelectronic impedance converters to provide industry leading stability with temperature. PiezoStar IEPE accelerometers generate up to 3x higher voltage sensitivity compared to quartz – which is ideal for miniaturization.

Vibration testing for dynamic temperature applications

PiezoStar accelerometers provide highly stable measurements with temperature. This “out-of-the-box” solution requires no additional installation tasks compared to other accelerometers. External temperature compensation is a time consuming process requiring temperature and sensitivity measurement in order to characterize variations with temperature. Common compensation methods use either a look-up table or a polynomial based correction. PiezoStar accelerometers do not require any additional measurements or calculations as the vibration sensing technique has inherent sensitivity stability with temperature.

PiezoStar element design from Kistler provides a wide operating frequency range together with extremely low sensitivity to temperature. This technology allows accelerometers to operate at temperature ranges from $-195 \dots 165^{\circ}\text{C}$ [$-320 \dots 330^{\circ}\text{F}$], providing stability especially in dynamic operating temperatures.



PiezoStar crystals from Kistler, combined with high gain integral hybrid microelectronics, provide very low sensitivity variation over the operating temperature range in comparison to other IEPE accelerometer materials such as quartz and ceramics.

As shown in Fig. 1, PiezoStar IEPE accelerometer sensitivity deviation with temperature results in over 10 times less error due to temperature compared with typical IEPE accelerometer types.

PiezoStar accelerometer features:

- High voltage sensitivity (up to 3x higher than quartz) with inherent benefits for miniaturization
- Low temperature dependence, nearly eliminating sensitivity temperature errors, thus providing a more accurate measurement
- PiezoStar is a rigid material providing high stiffness to optimize accelerometer seismic element resonance frequencies and provide wide, usable frequency ranges.
- Wide operating temperature range, voltage mode (IEPE) operation from $-55 \dots 165^{\circ}\text{C}$ [$-65 \dots 330^{\circ}\text{F}$]; special products satisfy cryogenic operation to -195°C [-320°F]
- The PiezoStar growing process is reproduced on an industrial scale.
- Tested and successfully used in demanding applications for acceleration, pressure and force measurement

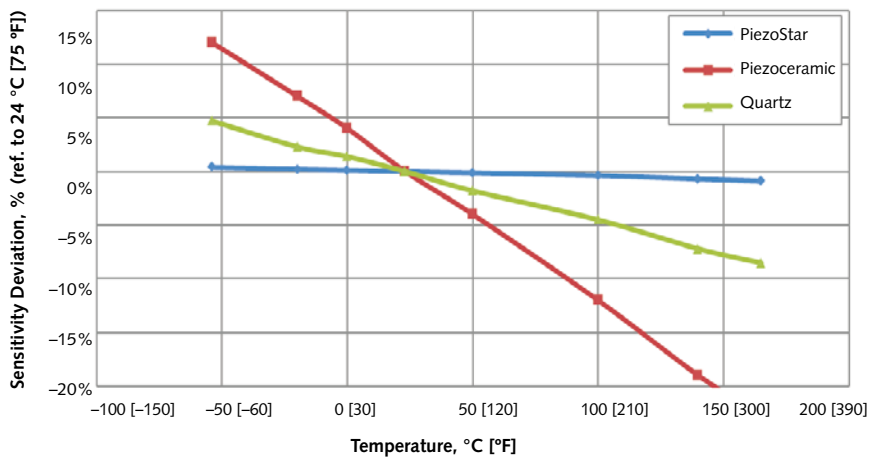

PiezoStar IEPE shear accelerometer

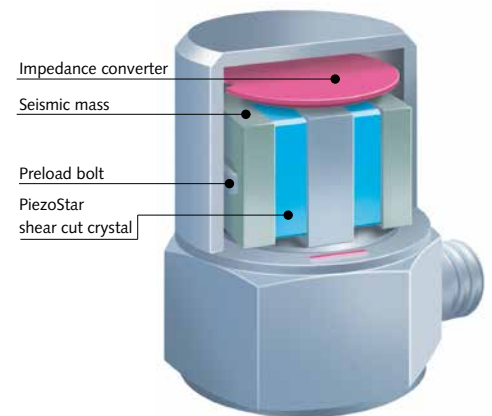

Fig. 1: Typical sensitivity deviation with temperature in °Fahrenheit (PiezoStar, Quartz, Piezoceramic)

PiezoStar IEPE accelerometer applications

Applications include automotive under the hood and under the vehicle testing, aviation/aerospace applications and environmental/product testing, which require dynamic temperature testing. PiezoStar accelerometers are designed with hermetic titanium construction and a variety of mounting, electrical connector orientations and ground isolation options. The accelerometer requires an IEPE compatible DC power supply to power the sensors. Such power supplies are available as stand-alone equipment or can be integrated with modern data acquisition equipment.

Applications

Vehicle R&D

Vehicle NVH (Noise Vibration Harshness) has requirements to mount accelerometers on the engine, powertrain, mounts, chassis and underbody. Vehicles, subsystems and components are exposed to a variety of environments to validate the design. Examples include dyno-testing, road testing at proving grounds in hot and cold locations, and durability testing. Such testing validates the reliability and structural performance over the operational environments.



Environmental and product testing

Environmental and product testing exposes products to a full range of conditions, including temperature, vibration/shock and humidity, to validate reliability during development/production. Control and response accelerometers are exposed to these extreme conditions, as well as the equipment under test. PiezoStar accelerometers minimize temperature errors and provide accurate control and vibration measurements.



Aviation/aerospace R&D and flight test

Flight test has requirements for wide temperature ranges from hot desert to high altitude locations. Such testing validates the reliability and structural performance over the operational envelope. PiezoStar accelerometers minimize temperature measurement errors for system, sub-system and component level testing.











Special application:

Cryogenic structural testing

Standard PiezoStar IEPE accelerometers are well known for -55 ... 165°C [-65 ... 330°F] operation. A special 50 g, 100 mV/g model, Type 8703A50M8, provides operation up to -195°C [-320°F]. Testing of space-based structures uses low level excitations and requires a high dynamic range measurement. Type 8703A50M8 has 8.8 grams of mass and over 90 dB dynamic range, providing precise measurement is taken.









Product overview – DC & charge accelerometers

Type	Sensor family	Sensing Technology	Measuring range (g)																					
			K-Beam capacitive	PiezoStar	Ceramic	Quartz	2	3	5	10	25	50	100	250	500	1 000	2 000	5 000	10 000	20 000	50 000			
MEMS capacitive	8316A...	Single-axis Capacitive DC response 	■																					
	8396A...	Triaxial capacitive DC response 	■																					
Charge output piezoelectric	8044A	Single-axis Piezoelectric Shock, cryo to high temps. 																					■	
	8202A...	Single-axis piezoelectric, high temp. 																					■	
	8203A...	Single-axis piezoelectric, high temp. 																					■	
	8274A / 8276A...	Single-axis Piezoelectric, high temp. 																					■	
	8278A...	Single-axis piezoelectric miniature, high temp. 																					■	
	8290A...	Triaxial piezoelectric, high temp. 																						■
	8248A3	Triaxial piezoelectric, high temp. 																						■



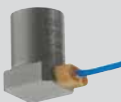

Frequency response Hz (±5%)										Operating temperature range °C [°F]										Mass (grams)	Mounting					TEDS	Ground isolated	IP68	Page	
0	0.5	1	5	500	1 000	5 000	8 000	10 000	12 000	-195 [-320]	-75 [-100]	-55 [-65]	-40 [-40]	0 [32]	65 [150]	80 [175]	120 [250]	165 [330]	200 [390]		250 [480]	Through hole	Stud	Adhesive	Clip					Magnet
[Blue bar: 0 to 5000 Hz]										[Blue bar: -55 to 120 °C]										15	<input checked="" type="checkbox"/>		<input checked="" type="checkbox"/>		<input checked="" type="checkbox"/>		<input checked="" type="checkbox"/>			20
[Blue bar: 0 to 5000 Hz]										[Blue bar: -55 to 120 °C]										30	<input checked="" type="checkbox"/>	<input checked="" type="checkbox"/>	<input checked="" type="checkbox"/>		<input checked="" type="checkbox"/>		<input checked="" type="checkbox"/>	<input checked="" type="checkbox"/>		21
										[Blue bar: -195 to 120 °C]										7		<input checked="" type="checkbox"/>	<input checked="" type="checkbox"/>		<input checked="" type="checkbox"/>					22
										[Blue bar: 0 to 12000 Hz]										14.5		<input checked="" type="checkbox"/>	<input checked="" type="checkbox"/>		<input checked="" type="checkbox"/>					22
										[Blue bar: 1000 to 5000 Hz]										44		<input checked="" type="checkbox"/>	<input checked="" type="checkbox"/>		<input checked="" type="checkbox"/>					22
										[Blue bar: 0 to 12000 Hz]										4		<input checked="" type="checkbox"/>	<input checked="" type="checkbox"/>		<input checked="" type="checkbox"/>					22
										[Blue bar: 0 to 12000 Hz]										0.7			<input checked="" type="checkbox"/>				<input checked="" type="checkbox"/>			22
										[Blue bar: 1000 to 5000 Hz]										53		<input checked="" type="checkbox"/>			<input checked="" type="checkbox"/>					23
										[Blue bar: 0 to 12000 Hz]										10.4	<input checked="" type="checkbox"/>		<input checked="" type="checkbox"/>				<input checked="" type="checkbox"/>			23

Product overview – single-axis IEPE accelerometers

Type	Sensor family	Sensing technology				Measuring range (g)																	
		K-Beam capacitive	PiezoStar	Ceramic	Quartz	2	3	5	10	25	50	100	250	500	1 000	2 000	5 000	10 000	20 000	50 000			
8080A	Single-axis PiezoStar shear, back-to-back reference sensor 		■											■									
8640A...	Single-axis PiezoBeam, modal analysis, high output, small 			■				■															
8702B... / 8704B...	Single-axis quartz shear, cryo to high temp. or general vibration 				■			■															
8703A... / 8705A...	Single-axis PiezoStar, cryo to high temp. and high thermal stability 		■					■															
8712B...	Single-axis, high sensitivity PiezoStar, cryo to high temp./ high thermal stability 		■					■															
8714B...	Single-axis, ceramic annular shear, through hole, high temp. 			■						■													
8715A/B...	Single-axis PiezoStar miniature, through hole, high temp./high thermal stability 		■							■													
8728A...	Single-axis quartz shear miniature 		■		■									■									

Frequency response Hz ($\pm 5\%$)											Operating temperature range $^{\circ}\text{C}$ [$^{\circ}\text{F}$]											Mass (grams)	Mounting					TEDS	Ground isolated	Page
0	0.5	1	5	500	1 000	5 000	8 000	10 000	12 000	-195 [-320]	-75 [-100]	-55 [-65]	-40 [-40]	0 [32]	65 [150]	80 [175]	120 [250]	165 [330]	200 [390]	250 [480]	Through hole		Stud	Adhesive	Clip	Magnet	Ground isolated			
																					175		■				■	51		
																					3.5		■	■	■	■	■	24		
																					8		■	■		■	■	25		
																					8		■	■		■	■	26		
																					72		■				■	28		
																					5	■		■		■	■	28		
																					2	■		■		■	■	27, 28		
																					1.6			■				29		







Product overview – single-axis IEPE accelerometers

Sensor family		Sensing technology	Measuring range (g)																					
			K-Beam capacitive	PiezoStar	Ceramic	Quartz	2	3	5	10	25	50	100	250	500	1 000	2 000	5 000	10 000	20 000	50 000			
Type																								
Single-axis Piezotron/IEPE	8730A...	Single-axis quartz shear miniature, cryo temp. 				■																		
	8742A / 8743A	Single-axis quartz shear shock 				■																		
	8774B / 8776B...	Single-axis ceramic shear, modal analysis, general vibration 			■																			
	8778A...	Single-axis ceramic shear, miniature tear-drop 			■																			
	8784A / 8786A...	Single-axis ceramic shear, high sensitivity, low-level vibration 			■																			

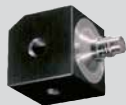
* For higher g range, please contact your local Kistler representative.

Frequency response Hz ($\pm 5\%$)										Operating temperature range $^{\circ}\text{C}$ [$^{\circ}\text{F}$]										Mass (grams)	Mounting					TEDS	Ground isolated	IP68	Page		
0	0.5	1	5	500	1 000	5 000	8 000	10 000	12 000	-195 [-320]	-75 [-100]	-55 [-65]	-40 [-40]	0 [32]	65 [150]	80 [175]	120 [250]	165 [330]	200 [390]		250 [480]	Through hole	Stud	Adhesive	Clip					Magnet	Ground isolated
																						2		■	■		■			■	29
																						4.5		■							39
																						4		■	■		■			■	30, 31
																						0.4			■					■	32
																						21		■	■		■				32

Product overview – triaxial IEPE accelerometers

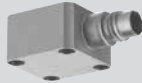
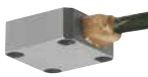
Sensor family		Sensing technology	Measuring range (g)																			
			K-Beam capacitive	PiezoStar	Ceramic	Quartz	2	3	5	10	25	50	100	250	500	1 000	2 000	5 000	10 000	20 000	50 000	
Type																						
8688A...	Triaxial PiezoBeam, miniature, modal, high output				■																	
8762A...	Triaxial annular ceramic shear, modal, rugged				■																	
8763B...	Triaxial ceramic shear miniature				■																	
8764B...	Triaxial ceramic shear, through hole, ground isolation				■																	
8765A...	Triaxial PiezoStar, through hole, high temp., thermal stability			■										■								
8766A...	Triaxial PiezoStar, Miniature, high temp., thermal stability			■																		
8792A...	Triaxial quartz shear, through hole, general vibration																					■
8793A...	Triaxial quartz shear, through hole, very low profile, cryo/ high temps.																					■
8794A...	Triaxial quartz shear, through hole, very low profile, high temps.																					■

Frequency response Hz (±5%)										Operating temperature range °C [°F]										Mass (grams)	Mounting					TEDS	Ground isolated	IP68	Page					
0	0.5	1	5	500	1 000	5 000	8 000	10 000	12 000	-195 [-320]	-75 [-100]	-55 [-65]	-40 [-40]	0 [32]	65 [150]	80 [175]	120 [250]	165 [330]	200 [390]		250 [480]	Through hole	Stud	Adhesive	Clip					Magnet	Ground isolated	IP68		
																						6.5		■	■	■	■	■				33		
																						23		■	■			■	■				33	
																						4		■	■		■	■		■				34
																						6	■		■		■	■						35
																						6.4	■		■				■				36	
																						4.5	■	■		■	■			■				36
																						29	■		■			■	■				37	
																						11	■		■			■					38	
																						7.6	■		■				■				38	

Product overview – others

IEPE impedance head													
Type	Range vibration	Sensitivity	Force range	Sensitivity	Operating temp. range	Mass	Mounting					Page	
							g	mV/g	N [lbf]	mV/N [mV/lbf]	°C [°F]		grams
8770A5		±5	1 000	±22 [±5]	227 [1 000]	-55 ... 80 [-65 ... 175]	34	x			x	x	40
8770A50		±50	100	±222 [±50]	23 [100]	-55 ... 120 [-65 ... 250]	34	x			x	x	40

IEPE impact hammers							
Type	Range	Sensitivity	Frequency response	Operating temp. range	Mass	Page	
							N [lbf]
9722A500		500 [100]	10 [50]	8 200	-20 ... 70 [-5 ... 160]	100	42
9722A2000		2 000 [500]	2 [10]	9 300	-20 ... 70 [-5 ... 160]	100	42
9724A2000		2 000 [500]	2 [10]	6 600	-20 ... 70 [-5 ... 160]	250	42
9724A5000		5,000 [1 000]	1 [5]	6 900	-20 ... 70 [-5 ... 160]	250	42
9726A5000		5 000 [1 000]	1 [5]	5 000	-20 ... 70 [-5 ... 160]	500	42
9726A20000		20 000 [5 000]	0.2 [1]	5 400	-20 ... 70 [-5 ... 160]	500	42
9728A20000		20 000 [5 000]	0.2 [1]	1 000	-20 ... 70 [-5 ... 160]	1 500	42

Charge force sensors												
Type	Range compression	Range tension	Sensitivity	Operating temp. range	Mass	Mounting					Page	
						N [lbf]	N [lbf]	pC/N [pC/lbf]	°C [°F]	grams		stud
9212		+22 000 [+5 000]	-2 200 [-500]	-11 [-50]	-240 ... 150 [-400 ... 300]	18	x					40





IEPE force sensors												
Type	Range compression	Range tension	Sensitivity	Operating temp. range	Mass	Mounting					Page	
						N [lbf]	N [lbf]	mV/N [mV/lbf]	°C [°F]	grams		stud
9712B5		+22 [+5]	-22 [-5]	180 [800]	-50 ... 120 [-60 ... 250]	19	x					41
9712B50		+220 [+50]	-220 [-50]	22 [100]	-50 ... 120 [-60 ... 250]	19	x					41
9712B250		+1 100 [+250]	-1 100 [-250]	4.5 [20]	-50 ... 120 [-60 ... 250]	19	x					41
9712B500		+2 200 [+500]	-2 200 [-500]	2.25 [10]	-50 ... 120 [-60 ... 250]	19	x					41
9712B5000		+22 000 [+5 000]	-22 000 [-5 000]	0.225 [1]	-50 ... 120 [-60 ... 250]	19	x					41

Product overview – others

Rotational accelerometers															
Type		Range	Sensitivity	Frequency response	Operating temp. range	Threshold	Mass	Ground isolated	Connector	Mounting					Page
		krads/s ²	μV/rad/s ²	Hz	°C [°F]	rads/s ²	grams		Location	stud	adhesive	clip	magnetic	screw	
8838		±150	34	1 ... 2 000	-55 ... 120 [-65 ... 250]	4	18.5	yes	4 pin pos. I side					x	43
8840		±150	34	1 ... 2 000	-55 ... 120 [-65 ... 250]	4	18.5	yes	4 pin pos. I side					x	43

Acoustic emission sensors														
Type		Sensitivity	Frequency response	Operating temp. range	Mass	Ground isolated	Connector	Mounting					Page	
		dBref 1V/ (m/s)	Hz (±10 dB)	°C [°F]	grams		Location	stud	adhesive	clip	magnetic	screw		
8152C0...		57	50 000 ... 400 000	-55 ... 165 [-65 ... 330]	29	yes	integral cable pigtails I side					x	x	44
8152C1...		48	100 000 ... 900 000	-55 ... 165 [-65 ... 330]	29	yes	integral cable pigtails I side					x	x	44

See pages 43 ... 57 for mounting accessories, cables and electronics.

High temperature accelerometers														
Type		Range	Frequency response	Operating temp. range	Mass	Connector	Mounting					IP 68	Page	
		gpk	Hz (±5%)	°C [°F]	grams	Location	stud	adhesive	clip	magnetic	screw			
8205Bx1... 8205Bx2... 8205Bx3...		±250	1... 9 000 1... 8 000 1... 7 500	-55... 260 [-67... 500]	50	7/16-27 or integral cable pigtails I side						x	x	45
8207Ax1... 8207Ax2...		±500	1... 4 000	-55... 480 [-67... 896]	75 110	integral cable LEMO, 7/16-27, or pigtails I side						x	x	45
8209Ax1... 8209Ax2...		±500	1... 4 000	-55... 700 [-67... 1292]	75 110	integral cable LEMO, 7/16-27, or pigtails I side						x	x	45
8211A...		±500	1... 4 000	-55... 700 [-67... 1292]	30	integral cable LEMO, 7/16-27, or pigtails I side						x	x	45

Static and low frequency vibration

K-Beam MEMS capacitive, low frequency accelerometers – single-axis

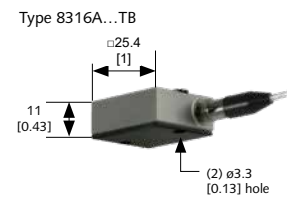
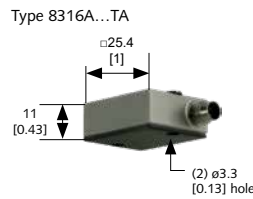
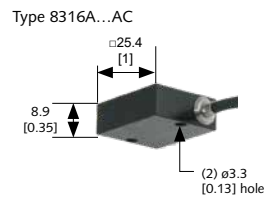
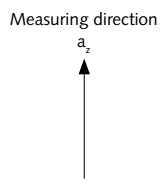

Type 8316...

Technical data / Type		...A2D0...	...A010...	...A030...	...A050...	...A100...	...A200...
Range	g	±2	±10	±30	±50	±100	±200
Sensitivity, ±5% (±4V FSO version) (2.5 ±2V FSO version) (±8V FSO differential vers.)	mV/g	2 000	400	133.3	80	40	20
	mV/g	1 000	200	66.6	40	20	10
	mV/g	4 000	800	266.6	160	80	40
Zero g output (±4V FSO version) (2.5 ±2V FSO version) (±8V FSO differential vers.)	mV	0 ±60					
	mV	2 500 ±30					
	mV	0 ±120					
Frequency response,	Hz						
±5%, min.		0 ... 250	0 ... 1 000	0... 1 500	0... 1 500	0... 1 500	0... 1 500
±5%, typ.		0 ... 900	0... 2 000	0... 2 300	0... 2 700	0... 3 000	0... 3 500
Resonance frequency mounted (nom.)	kHz	1.2	3.2	5.2	6.5	8.5	11
Amplitude linearity, typ.	%FSO	±0.1					
Resolution/Threshold, typ.	mg _{rms}	0.1	0.5	1.47	2.45	4.9	9.8
Transverse sensitivity, typ	%	1					
Shock half sine	g _{pk}	6 000 (200 µs)					
Temp. coeff. bias, typ.	mg/°C [mg/°F]	±0.1 [±0.06]	±0.5 [±0.3]	±1.5 [±0.8]	±2.5 [±1.3]	±5.5 [±2.8]	±10 [±5.5]
Temp. coeff. sensitivity, typ.	ppm/°C [ppm/°F]	±100 [±55]					
Operating temp. range	°C [°F]	-55 ... 125 [-65 ... 260]					
Phase shift max., @ 100 Hz	degree	10					
Current nom.	mA	4					
Voltage	VDC	6 ... 50					
Connector	type	4 pin pos.					
Housing/base	material	Titanium (TA, TB housing) / Aluminum (AC housing)					
Sealing	type	Environmental (AC housing) / Hermetic (TA, TB housing)					
Mass	grams	15 (TA, TB Housing), 12 (AC Housing)					
Ground isolated		yes					
Data sheet		8316A_003-324					

Properties	Small, lightweight variable capacitance sensing element; integral cable and connector options; CE compliant
Application	Low frequency vibration measurements for automotive ride quality and aerospace structural testing
Accessories	Power supply: 1-Channel, Type 5210 ; 15-Channels, Type 5146A15 Mounting cube: Type 8522
Versions	...A0: 0±4 V FSO ...AT: 0±4 V FSO, with temp. output ...B0: 2.5±2 V FSO ...BT: 2.5±2 V FSO, with temp. output ...C0: 0±4 V FSO differential ...D0: 0±8 V FSO differential ...AC: Al. housing, with integral cable ...TA: Ti. housing, with 4-pin connector ...TB: Ti. housing, with integral cable

Static and low frequency vibration

K-Beam MEMS capacitive, low frequency accelerometers – triaxial

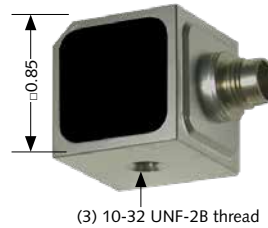
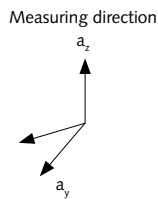

Type 8396...							
Technical data / Type		...A2D0...	...A010...	...A030...	..A050...	..A100...	..A200...
Range	g	±2	±10	±30	±50	±100	±200
Sensitivity, ±5% (±4V FSO version) (2.5 ±2V FSO version) (±8V FSO differential vers.)	mV/g						
	mV/g	2 000	400	133.3	80	40	20
	mV/g	1 000	200	66.6	40	20	10
	mV/g	4 000	800	266.6	160	80	40
Zero g output (±4V FSO version) (2.5 ±2V FSO version) (±8V FSO differential vers.)	mV	0 ±60 2 500 ±30 0 ±120					
	mV						
	mV						
	mV						
Frequency response, ±5%, min.	Hz	0 ... 250	0 ... 1 000	0... 1 500	0... 1 500	0... 1 500	0... 1 500
		±5%, typ.	0... 900	0... 2 000	0... 2 300	0... 2 700	0... 3 000
Resonance frequency mounted (nom.)	kHz	1.2	3.2	5.2	6.5	8.5	11
Amplitude linearity, typ.	%FSO	±0.1					
Resolution/Threshold, typ.	mg _{rms}	0.1	0.5	1.47	2.45	4.9	9.8
Transverse sensitivity, typ.	%	1					
Shock half sine	g _{pk}	6 000 (200 µs)					
Temp. coeff. bias, typ.	mg/°C [mg/°F]	±0.1 [±0.06]	±0.5 [±0.3]	±1.5 [±0.8]	±2.5 [±1.4]	±5 [±2.8]	±10 [±5.5]
Temp. coeff. sensitivity, typ.	ppm/°C [ppm/°F]	±100 [±55]					
Operating temp. range	°C [°F]	-55 ... 125 [-65 ... 260]					
Phase shift max., @ 100 Hz	°	10					
Current nom.	mA	12					
Voltage	VDC	6 ... 50					
Connector	type	9 pin pos. circular					
Housing/base	material	Titanium					
Sealing	type	Hermetic (...TF/...TG options: IP68 (waterproof) tested at 10 bar for 48 hours)					
Mass	grams	31 (AT, BT Output), 33 (CT, DT Output)					
Ground isolated		yes					
Data sheet		8396A_003-325					

Properties	Bipolar output; 0±4 V FS, zero volt output at zero g; ground isolated; low noise; operating from voltage supply; CE compliant	
Application	Instrument grade triaxial accelerometer; well-suited for automotive, aerospace, civil engineering, R&D, OEM and structural analysis	
Accessories	Cable: Types 1792A...K00, 1792A...K01 Mounting: adhesive mounting base Type 8466K01	Mounting: stud mounting base Type 8466K02 Mounting: magnetic mounting base Type 8466K03 Power supply: 15-Channels, Type 5146A15
Versions	...AT: 0 ±4 V FSO, with temp. output ...BT: 2.5 ±2 V FSO, with temp. output ...CT: 0 ±4 V FSO, diff. output, with temp. output ...DT: 0 ±8 V FSO, diff. output, with temp. output ...TA: Titanium, Hermetic, 9 pin pos. circular ...TB: Titanium, internal cable, pigtail, braid shield	...TC: Titanium, internal cable, 9 pin D-Sub, braid shield ...TD: Integral Cable IP64, pigtail ...TE: Integral Cable IP64, 9 pin D-Sub ...TF: Integral cable IP68 (waterproof), pigtail ...TG: Integral cable IP68 (waterproof), 9 pin D-Sub

General vibration

Charge accelerometers – single-axis

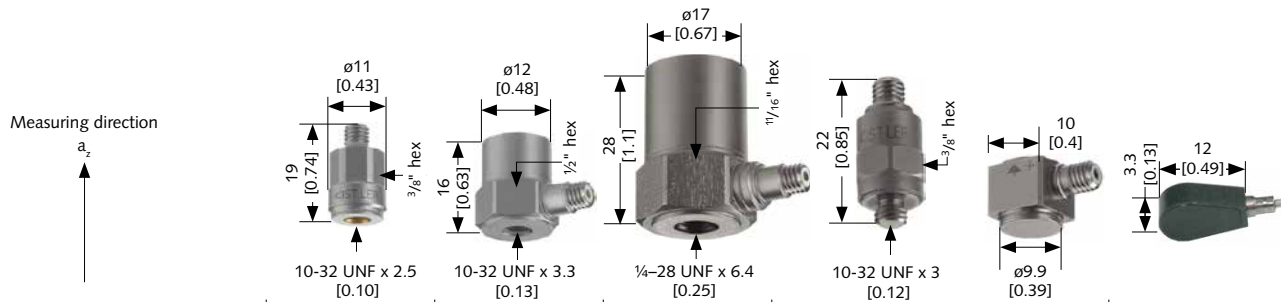

		Type 8044	Type 8202...	Type 8203...	Type 8274...	Type 8276...	Type 8278...
Technical data / Type			...A10...	...A50...	...A5...	...A5...	...A500...
Range	g	-20 000 ... 30 000	±2 000	±1 000	±2 000	±2 000	±500
Sensitivity, ±5%	pC/g	-0.3	-10 (±15%)	-50 (±15%)	-5.5	-5.5	-1.3
Frequency response, ±5%	Hz	near DC ... 8 000	5 ... 10 000	5 ... 4 000	1 ... 12 000 (7%)	1 ... 7 000	1 ... 10 000
Resonance frequency mounted (nom.)	kHz	≥90	≥45	≥24	≥50	≥40	≥40
Threshold	mg _{rms}	depends on charge amplifier settings					
Transverse sensitivity	%	≤5	1.5	1.5	1.5	1.5	3
Non-linearity	%FSO	±1	±1	±1	±1	±1	±1
Temp. coeff. sensitivity	%/°C [%/°F]	-0.02 [-0.01]	0.13 [0.07]	0.13 [0.07]	0.11 [0.06]	0.11 [0.06]	0.18 [0.1]
Operating temp. range	°C [°F]	-195 ... 200 [-320 ... 400]	-70 ... 250 [-95 ... 480]	-70 ... 250 [-95 ... 480]	-55 ... 165 [-65 ... 330]	-55 ... 165 [-65 ... 330]	-75 ... 180 [-100 ... 350]
Connector	type	10-32 neg.	10-32 neg.	10-32 neg.	10-32 neg.	10-32 neg.	10-32 neg.
Housing/base	material	17-4 PH St. Stl.	17-4 PH St. Stl.	Stainless steel	Stainless steel	Stainless steel	Titanium
Sealing	type	Epoxy	Hermetic/ Ceramic	Hermetic/ Ceramic	Hermetic	Hermetic	Hermetic
Mass	grams	7	14.5	44.5	4	4	0.7
Ground isolated		no	with pad	with pad	with pad	no	no
Data sheet		8044_000-209	8202A_000-212		8276A_000-213		8278A_000-611

Properties	Wide measuring range; stable quartz element; lightweight, miniature package	High temp. (480 °F); ceramic shear sensing element; low transverse sensitivity	Ceramic shear sensing element, wide frequency response; low transverse sensitivity; lightweight, rugged connector; ideal for OEM applications	Ultra-low base strain; wide frequency response; ground isolated, integral cable; high temp.
Application	Measuring and analyzing shock and vibration with high amplitudes	Automotive, aerospace and environmental testing where low impedance sensors are limited by operating temperature	Impact and vibration related applications including condition monitoring and vehicle testing	Precision vibration measurements; modal analysis
Accessories	Cable: Type 1631C Charge amp.: Type 5000 series	Cable: Type 1631C Charge amplifier: 50xx series or Charge converter Type 5050B and Coupler Type 51xx series		

General vibration

Charge accelerometers – triaxial

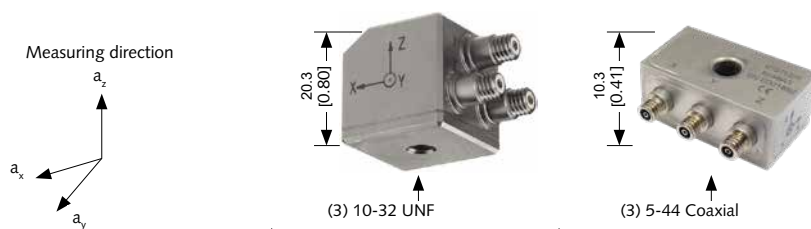

		Type 8290...	Type 8248A3
Technical data / Type		...A25M5	
Range	g	±1 000	±2 000
Sensitivity	pC/g	-25	-3.0 ± 20%
Frequency response	Hz	5 ... 4 000 (±10%)	8 000 (±10%, typ.)
Resonance frequency mounted (nom.)	kHz	20	26
Threshold	mg _{rms}	1	1
Transverse sensitivity	%	1.5	5
Non-linearity	%FSO	±1	±1
Temp. coeff. sensitivity	%/°C [%/°F]	0.13 [0.07]	See data sheet plot
Operating temp. range	°C [°F]	-70 ... 250 [-95 ... 480]	-54... 260 [-65 ... 500]
Connector	type	10-32 neg.	3 x 5-44 Coaxial
Housing/base	material	Stainless steel	Titanium
Sealing	type	Hermetic/Ceramic	Hermetic/Ceramic
Mass	grams	53	10.4
Ground isolated		no	yes
Data sheet		8290A_000-215	8248A3_003-540
Properties		Ceramic shear sensing element; low transverse sensitivity; extended temperature operation	Ceramic shear sensing element; low transverse sensitivity; high temperature (260°C)
Application		General vibration measurements with varying test conditions, vehicle vibration and NVH testing, general lab/R&D and ESS	General vibration measurements with varying test conditions, vehicle vibration and NVH testing, general lab/R&D and ESS
Accessories		Cable: Type 1631C Charge amplifier: Type 50xx series or Charge converter Type 5050B and Coupler Type 51xx series Mounting stud: Types 8402, 8411	Cable: Type 1766AK03SP or 1766AK04SP Charge amplifier: Type 50xx series or Charge converter Type 5050B and Coupler Type 51xx series Mounting screw kit: 8446AE5 or 8446AM5

General vibration

IEPE accelerometers – single-axis

Measuring direction

a_z

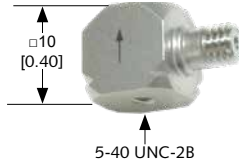

Type 8640...				
Technical data / Type		...A5	...A10	...A50
Range	g	±5	±10	±50
Sensitivity, ±5%	mV/g	1 000	500	100
Frequency response, ±5%	Hz	0.5 ... 3 000		0.5 ... 5 000
Resonance frequency mounted (nom.)	kHz	≥17		≥25
Threshold	mg _m	0.14	0.16	0.36
Transverse sensitivity	%	1.5		
Non-linearity	%FSO	±1		
Shock (1 ms pulse)	g _{pk}	7 000		10 000
Temp. coeff. sensitivity	%/°C [%/°F]	0.13 [0.07]	0.16 [0.09]	
Operating temp. range	°C [°F]	-40 ... 55 [-40 ... 130]	-40 ... 65 [-40 ... 150]	
Power supply current	mA	2 ... 20		
Power supply voltage	VDC	22 ... 30		
Connector	type	10-32 neg.		
Housing/base	material	Titanium		
Sealing	type	Hermetic		
Mass	grams	3.5		
Ground isolated		with pad		
Data sheet		8640A_000-842		
Properties	High sensitivity, low mass, low noise, low transverse sensitivity and ground isolated; CE compliant			
Application	Modal analysis or structural investigations			
Accessories	Cable: Type 1768A...K01 Coupler: Type 5100 series Mounting clip, ground isolated: Type 800M156 Mounting base, ground isolated: Type 800M158 Mounting magnetic base: Type 800M160			
Versions	...T: TEDS option (see p. 69)			

General vibration

IEPE accelerometers – single-axis

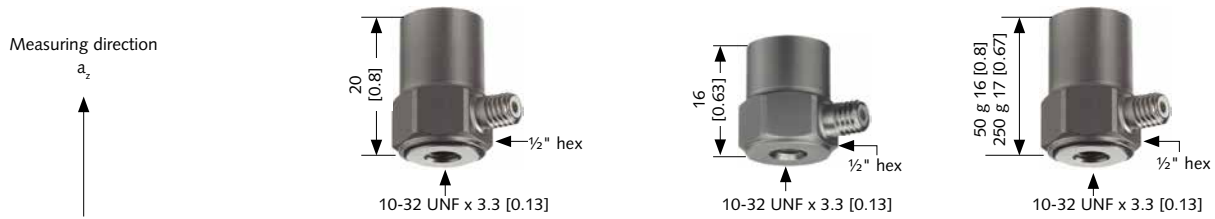

		Type 8702...				Type 8703...	
Technical data / Type		...B25	...B50	...B100	...B500	...A50	...A250
Range	g	±25	±50	±100	±500	±50	±250
Sensitivity, ±5%	mV/g	200	100	50	10	100	20
Frequency response, ±5%	Hz	1 ... 8 000	0.5 ... 10 000		1 ... 10 000	0.5 ... 10 000	
Resonance frequency mounted (nom.)	kHz	>54				>40	>50 >70 (M5)
Threshold	g_{rms}	0.002	0.004	0.006	0.01	0.0012	0.006
Transverse sensitivity	%	1.5				3	
Non-linearity	%FSO	±1				±1	
Shock (1 ms pulse)	g_{pk}	2 000			5 000	2 000	
Temp. coeff. sensitivity	%/°C %/°F	-0.06 [-0.03]				0.004 [0.002]	
Operating temp. range	°C [°F]	-55 ... 100 [-65 ... 210]			-55 ... 100 [-65 ... 210]	-196 ... 165 [-320 ... 330]	
Power supply current	mA	4				4	
Power supply voltage	VDC	20 ... 30				20 ... 36	
Connector	type	10-32 neg.				10-32 neg.	
Housing/base	material	Titanium/Stainless steel				Titanium	
Sealing	type	Hermetic				Hermetic	
Mass	grams	8.7			8.2	10	8.1
Ground isolated		with pad/M1				yes	
Data sheet		8702B_000-239			8702B_000-238	8703A_000-557	

Properties	Ultra-low base strain; low thermal transient response; quartz-shear sensing elements; CE compliant	Low impedance voltage output; ultra low base strain; ultra-low temp. coefficient of sensitivity with PiezoStar; CE compliant
Application	General purpose vibration measurement, vehicle or environmental testing, ESS and modal analysis	Dynamic temperature environments; general purpose vibration measurement, vehicle or environmental testing, ESS and modal analysis
Accessories	Cable: Types 1761B, 1761C Coupler: Type 5100 series Mounting pad: Type 8436 Mounting magnet: Type 8452A Triaxial mounting cube: Type 8502	Cable: Types 1761B, 1761C Coupler: Type 5100 series Mounting pad: Type 8436 Mounting magnet: Type 8452A Triaxial mounting cube: Type 8502
Versions	...T: TEDS option (see p. 69) ...M1: ground isolated	...M1: ground isolated ...M5: high temp. 165 °C [330 °F] ...M8: cryo temp. -196 °C [-320 °F] ...T: TEDS option (see p. 69)

General vibration

IEPE accelerometers – single-axis

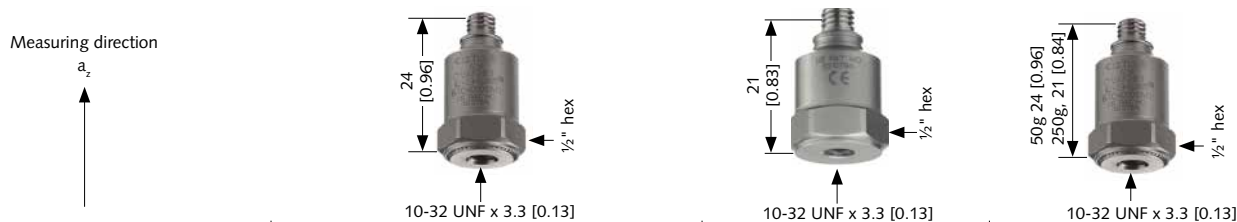

		Type 8704...					Type 8705...	
Technical data / Type		...B25	...B50	...B100	...B500	...B5000	...A50	...A250
Range	g	±25	±50	±100	±500	±5 000	±50	±250
Sensitivity, ±5%	mV/g	200	100	50	10	1	100	20
Frequency response, ±5%	Hz	1 ... 8 000	0.5 ... 10 000		1 ... 10 000		0.5 ... 10 000	
Resonance frequency mounted (nom.)	kHz	>54					>40	>50 >70 (M5)
Threshold	mg _{rms}	2	4	6	10	130	1.2	6
Transverse sensitivity	%	1.5					3	
Non-linearity	%FSO	±1					±1	
Shock (1 ms pulse)	g _{pk}	2 000			5 000	10 000	2 000	
Temp. coeff. sensitivity	%/°C [%/°F]	-0.06 [-0.03]					0.004 [0.002]	
Operating temp. range	°C [°F]	-55 ... 100 [-65 ... 210]					-55 ... 165 [-65 ... 330]	
Power supply current	mA	2 ... 20					2 ... 20	
Power supply voltage	VDC	20 ... 30					20 ... 30	
Connector	type	10-32 neg.					10-32 neg.	
Housing/base	material	Titanium/Stainless steel					Titanium	
Sealing	type	Hermetic					Hermetic	
Mass	grams	7.5			7.1		7.6	6.7
Ground isolated		with pad/M1					with pad/M1	
Data sheet		8704B_000-239			8704B_000-238	8704B_000-240	8705A_000-557	

Properties	Ultra-low base strain, low thermal transient response, quartz-shear sensing elements; CE compliant	Low impedance voltage output; ultra low base strain; low thermal transient response, ultra-low temp. coefficient of sensitivity with PiezoStar; CE compliant
Application	General purpose vibration measurement, vehicle or environmental testing, ESS and modal analysis, shock measurement	Dynamic temperature environments; general purpose vibration measurement, vehicle or environmental testing, ESS and modal analysis
Accessories	Cable: Types 1761B, 1761C Coupler: Type 5100 series Mounting pad: Type 8436 Mounting magnet: Type 8452A Triaxial mounting cube: Type 8502	Cable: Types 1761B, 1761C Coupler: Type 5100 series Mounting pad: Type 8436 Mounting magnet: Type 8452A Triaxial mount. cube: Type 8502
Versions	...T: TEDS option (see p. 69) ...M1: ground isolated	...M1: ground isolated ...M5: high temp. 165°C [330°F]

General vibration

IEPE accelerometers – single-axis



		Type 8712...		Type 8714...	
Technical data / Type		...B5D0...		...B100...	
Range	g	±5		±100	
Sensitivity	mV/g	1 000±10%		50±10%	
Frequency response, ±5%	Hz	0.5 ... 3 000		1 ... 10 000	
Resonance frequency mounted (nom.)	kHz	>14		>36	
Threshold	mg _{rms}	0.1		2	
Transverse sensitivity	%	1		3	
Amplitude linearity	%FSO	±1		±1	
Shock (1 ms pulse)	g _{pk}	500		5 000	
Temp. coeff. sensitivity	%/°C [%/°F]	...HB/HI: 0.002 [0.001] ...CB: 0.06 [0.03]		-0.14 [-0.08]	
Operating temp. range	°C [°F]	...HB/HI: -55...165 [-65...330] ...CB: -196...125 [-320...260]		...M5: -55 ...165 [-65 ... 330] ...T: -40 ...121 [-40 ... 250]	
Power supply current	mA	2 ... 18		2 ... 18	
Power supply voltage	VDC	22 ... 30		20 ... 30	
Connector	type	10-32 neg.		10-32 neg.	
Housing/base	material	Titanium		Titanium/Aluminum	
Sealing	type	Hermetic		Hermetic	
Mass	grams	72		5	
Ground isolated		yes (...HI)		yes	
Data sheet		8712B_003-250		8714B_000-602	

Properties	Very high sensitivity & low noise; PiezoStar thermal stability; cryogenic and high temperature ranges; ground isolated; CE compliant	Low profile, high temperature ceramic annular shear accelerometer; CE compliant
Application	Suitable for microvibration testing at cryogenic temperature in Space applications, seismic applications, or any low amplitude vibration testing on heavy structures	Provides measurement solutions in hard to mount locations when cable orientation is important or height restrictions apply
Accessories	Cable: 1761B, 1761C Couple: Type 51xx series	Cable: Types 1761B, 1761C Coupler: Type 51xx series
Versions	...HB: High temp. up to 165°C [330°F] ...HI: Ground isolated, high temp. up to 165°C [330°F] ...CB: Cryogenic temp. down to -196°C [-320°F]	...T: TEDS option (see p. 69) ...M5: High temp. up to 165°C [330°F]

General vibration

IEPE accelerometers – single-axis

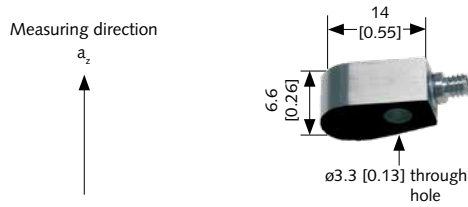

		Type 8715...	Type 8715...	Type 8715...	
Technical data / Type		...B250...	...B500...	...B1K0...	...A5000...
Range	g	±250	±500	±1 000	±5 000
Sensitivity	mV/g	20±10%	10±10%	5±10%	1±10%
Frequency response, ±5%	Hz	0.7 ... 10 000	0.7 ... 10 000	0.7 ... 10 000	2 ... 10 000
Resonance frequency mounted (nom.)	kHz	>60	>60	>60	>70
Threshold	mg _{rms}	<5	9	15	40
Transverse sensitivity	%	3	3	3	3
Amplitude linearity	%FSO	±1	±1	±1	±1
Shock	g _{pk}	5 000	5 000	5 000	8 000
Temp. coeff. sensitivity	%/°C [%/°F]	A00: -0.004 [-0.002] S00: 0.008	A00: -0.004 [-0.002] S00: 0.012 [0.007]	S00: 0.012 [0.007]	-0.01 [-0.005]
Operating temp. range	°C [°F]	Standard: -54 ...165 [-65 ... 329] TEDS: -40 ...121 [-40 ... 250]			
Power supply current	mA	2 ... 18	2 ... 18	2 ... 18	2 ... 18
Power supply voltage	VDC	20 ... 30	20 ... 30	20 ... 30	20 ... 30
Connector	type	5-44 neg.	5-44 neg.	5-44 neg.	5-44 neg.
Housing/base	material	Titanium	Titanium	Titanium	Titanium
Sealing	type	Hermetic	Hermetic	Hermetic	Hermetic
Mass	grams	For A00: 1.7 For S00: 2.0	For A00: 1.6 For S00: 1.9	For S00: 1.9	2.1
Ground isolated		yes	yes	yes	yes
Data sheet		8715B_003-343			8715A_000-603

Properties	Unique PiezoStar element; ultra-low temperature sensitivity; ground isolated; lightweight; hermetically sealed; CE compliant						
Application	Shock and vibration measuring in dynamic temperature conditions; general applications include: environmental testing (ESS) product acceptance/ qualification, and aviation testing						
Accessories	Cable: Types 1766A, 1761B, 1761C Coupler: Type 51xx series						
Versions	<table border="0"> <tr> <td>...A00: Adhesive version, high temp</td> <td>...S00: Center hole version, high temp</td> <td>...T: TEDS option (see p. 69)</td> </tr> <tr> <td>...S00: Center hole version, high temp</td> <td>...S00T: Center hole version, TEDS (see p. 69)</td> <td>...M5: High temp. up to 165°C [330°F]</td> </tr> </table>	...A00: Adhesive version, high temp	...S00: Center hole version, high temp	...T: TEDS option (see p. 69)	...S00: Center hole version, high temp	...S00T: Center hole version, TEDS (see p. 69)	...M5: High temp. up to 165°C [330°F]
...A00: Adhesive version, high temp	...S00: Center hole version, high temp	...T: TEDS option (see p. 69)					
...S00: Center hole version, high temp	...S00T: Center hole version, TEDS (see p. 69)	...M5: High temp. up to 165°C [330°F]					

General vibration

IEPE accelerometers – single-axis

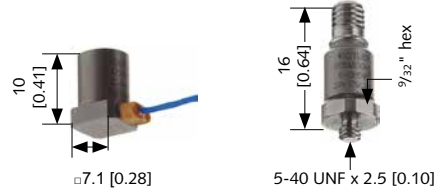
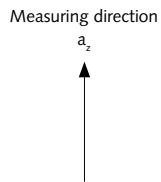

		Type 8728...	Type 8730...
		...A500	...A500
Technical data / Type			
Range	g	±500	
Sensitivity, ±5%	mV/g	10	10 (±10%)
Frequency response, ±5%	Hz	2 ... 10 000	
Resonance frequency mounted (nom.)	kHz	>76	
Threshold	mg _{rms}	20	
Transverse sensitivity	%	1.5	
Non-linearity	%FSO	±1	
Shock (1 ms pulse)	g _{pk}	5 000	
Temp. coeff. sensitivity	%/°C [%/°F]	-0.06 [-0.03]	
Operating temp. range	°C [°F]	-55 ... 120 [-65 ... 250]	-195 ... 120 [-320 ... 250]
Power supply current	mA	2 ... 20	2 ... 18
Power supply voltage	VDC	20 ... 30	
Connector	type	10-32 neg.	
Housing/base	material	Titanium	
Sealing	type	Welded/Epoxy	Hermetic
Mass	grams	1.6	1.9
Ground isolated		no	yes
Data sheet		8728A_000-247	8730A_000-248

Properties	Small, lightweight; 2 m integral cable; quartz-shear stability and precision; CE compliant	Quartz-shear sensing element; low impedance output; ultra-low base strain sensitivity; CE compliant
Application	Precision measurements on small, thin-walled structures or where space is limited, ideal for high frequency vibration measurements	Precision measurements on small, thin-walled structures and environmental testing
Accessories	Extension Cable: Types 1761B, 1761C Coupler: Type 5100 series	Cable: Types 1761B, 1761C Coupler: Type 5100 series Mounting pad: Types 8434, 8436M02
Versions		...AE: metric thread. (M3 x 0.5) 8 mm hex ...M1: ground isolated ...M8: cryo temp. -195°C [-320 °F]

General vibration

IEPE accelerometers – single-axis

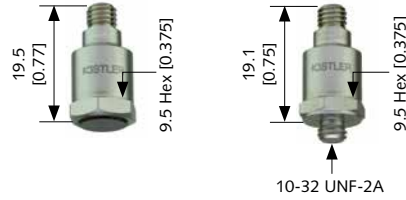
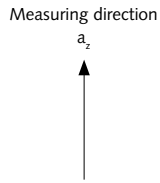

Type 8774...

Technical data / Type		...B050...	...B100...	...B250...	...B500...
Range	g	±50	±100	±250	±500
Sensitivity, ±15%	mV/g	100	50	20	10
Frequency response, ±5%	Hz	0.5 ... 10 000 (-S) 0.5 ... 8 000 (-A)		1 ... 10 000 (-S) 1 ... 8 000 (-A)	
Resonance frequency mounted (nom.)	kHz	>50		>70	
Threshold	mg _{rms}	<0.4	<0.6	<1.5	<2.5
Transverse sensitivity	%	2			
Non-linearity	%FSO	±1			
Shock (1 ms pulse)	g _{pk}	5 000			
Temp. coeff. sensitivity	%/°C [%/°F]	-0.01 [-0.006]		-0.03 [-0.02]	
Operating temp. range	°C [°F]	-54 ... 100 [-65 ... 212]			
Power supply current	mA	2 ... 18			
Power supply voltage	VDC	22 ... 30			
Connector	type	For connector versions: 10–32 neg; For integral cable versions: 10–32 pos.			
Housing/base	material	Titanium			
Sealing	type	Hermetic (...sp option: IP68 (waterproof) tested at 16 bar for 48 hours)			
Mass	grams	3.1 (S – Int. Stud); 2.9 (A – Adhesive)		2.8 (S – Int. Stud); 2.6 (A – Adhesive)	
Ground isolated		yes (A – Adhesive); with accessory (S – Stud)			
Data sheet		8774B_003-237			

Properties	High frequency response; high resolution, low noise; ground isolated adhesive mount option; CE compliant
Application	General purpose vibration measurement; modal/structural analysis; underwater applications
Accessories	Cable: Types 1761B, 1761C Coupler: Type 51... series Mounting pad: Type 8436 Mounting cubes: Type 8524, 8526 Mounting magnet: Type 8452A
Versions	...Ax: Adhesive mount ...Sx: Stud mount ...xsp: Integral cable IP68 (waterproof)

General vibration

IEPE accelerometers – single-axis

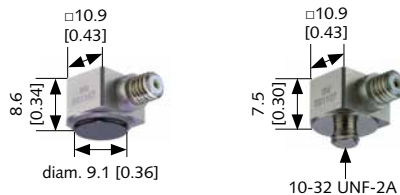
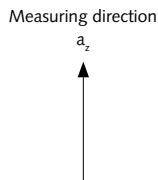

Type 8776...

Technical data / Type		...B050...	...B100...	...B250...	...B500...
Range	g	±50	±100	±200	±500
Sensitivity, ±15%	mV/g	100	50	20	10
Frequency response, ±5%	Hz	0.5 ... 10 000 (-S) 0.5 ... 8 000 (-A)		1 ... 10 000 (-S) 1 ... 8 000 (-A)	
Resonance frequency mounted (nom.)	kHz	>50		>70	
Threshold	mg _{rms}	<0.4	<0.6	<1.5	<2.5
Transverse sensitivity	%	2			
Non-linearity	%FSO	±1			
Shock (1 ms pulse)	g _{pk}	5,000			
Temp. coeff. sensitivity	%/°C [%/°F]	0.03 [0.02]		-0.011 [-0.006]	
Operating temp. range	°C [°F]	-54 ... 100 [-65 ... 212]			
Power supply current	mA	2 ... 18			
Power supply voltage	VDC	22 ... 30			
Connector	type	For connector versions: 10–32 neg; For integral cable versions: 10–32 pos.			
Housing/base	material	Titanium			
Sealing	type	Hermetic (...sp option: IP68 (waterproof) tested at 16 bar for 48 hours)			
Mass	grams	3.3 (S – Int. Stud); 3.3 (A – Adhesive)		3 (S – Int. Stud); 3 (A – Adhesive)	
Ground isolated		yes (A – Adhesive); with accessory (S – Stud)			
Data sheet		8774B_003-237			

Properties	High frequency response; high resolution, low noise; ground isolated adhesive mount option; CE compliant
Application	General purpose vibration measurement; modal/structural analysis; underwater applications
Accessories	Cable: Types 1761B, 1761C Coupler: Type 51.. series Mounting pad: Type 8436 Mounting cubes: Type 8524, 8526 Mounting magnet: Type 8452A
Versions	...Ax: Adhesive mount ...Sx: Stud mount ...xsp: Integral cable IP68 (waterproof)

General vibration

IEPE accelerometers – single-axis



		Type 8778...	Type 8784...	Type 8786...
		...A500	...A5	...A5
Technical data / Type				
Range	g	±500	±5	±5
Sensitivity	mV/g	10 (nom.)	1 000 (±10%)	1 000 (±10%)
Frequency response, ±5 %	Hz	2 ... 9 000	1 ... 6 000	1 ... 6 000
Resonance frequency mounted (nom.)	kHz	>70	>27	>27
Threshold	mg _{rms}	10	0.4	0.4
Transverse sensitivity	%	3	1.5	1.5
Non-linearity	%FSO	±1	±1	±1
Shock (1 ms pulse)	g _{pk}	5,000	2,500	2,500
Temp. coeff. sensitivity	%/°C [%/°F]	-0.14 [-0.08]	-0.05 [-0.03]	-0.05 [-0.03]
Operating temp. range	°C [°F]	-55 ... 120 [-65 ... 250]	-55 ... 80 [-65 ... 175]	-55 ... 80 [-65 ... 175]
Power supply current	mA	2 ... 20	2 ... 20	2 ... 20
Power supply voltage	VDC	18 ... 30	18 ... 30	18 ... 30
Connector	type	10-32 neg.	10-32 neg.	10-32 neg.
Housing/base	material	Aluminum/Titanium	Titanium	Titanium
Sealing	type	Epoxy	Hermetic	Hermetic
Mass	grams	0.4	21	21
Ground isolated		yes	with pad	with pad
Data sheet		8778A_000-256	8784A_000-257	8784A_000-257

Properties	Ultra-low base strain, low mass, ground isolated, integral cable (user specified length); CE compliant	Ceramic shear sensing element, low impedance, voltage mode, high sensitivity, high resolution; CE compliant
Application	Environmental/product testing on small, thin-walled structures or where space is limited and mass loading is of primary concern	Low level vibration and impact testing for applications including condition monitoring and vehicle testing
Accessories	Extension Cable: Types 1761B, 1761C Coupler: Type 5100 series Removal tool: Type 1378	Cable: Types 1761B, 1761C Coupler: Type 5100 series Adh. mounting pad: Type 8436 Mounting magnet: Type 8452
Versions	M14: twisted pair cable	

General vibration

IEPE accelerometers – triaxial

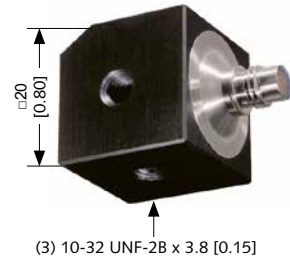
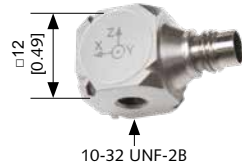
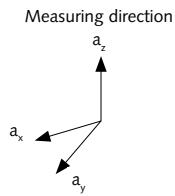

		Type 8688...			Type 8762...		
Technical data / Type		...A5	...A10	...A50	...A5	...A10	...A50
Range	g	±5	±10	±50	±5	±10	±50
Sensitivity, ±5%	mV/g	1 000	500	100	1,000	500	100
Frequency response, ±5%	Hz	0.5 ... 3 000		0.5 ... 5 000	0.5 ... 6 000		
Resonance frequency mounted (nom.)	kHz	>15		>25	>30		
Threshold	mg _{rms}	0.14	0.16	0.36	0.3	0.35	1.2
Transverse sensitivity	%	1.5			<5		
Non-linearity	%FSO	±1			±1		
Shock (1 ms pulse)	g _{pk}	7 000		10 000	5 000	7 000	
Temp. coeff. sensitivity	%/°C [%/°F]	0.17 [0.09]	0.23 [0.13]		-0.06 [-0.03]	-0.02 [-0.01]	
Operating temp. range	°C [°F]	-40 ... 55 [-40 ... 130]	-40 ... 65 [-40 ... 150]		-55 ... 80 [-65 ... 175]		
Power supply current	mA	2 ... 20			2 ... 18		
Power supply voltage	VDC	22 ... 30			20 ... 30		
Connector	type	4 pin pos.			4 pin pos.		
Housing/base	material	Titanium			Aluminum hard anodized		
Sealing	type	Hermetic			Welded/Epoxy		
Mass	grams	6.7	6.5		23		
Ground isolated		with pad			yes		
Data sheet		8688A_000-843			8762A_000-456		

Properties	Miniature high sensitivity, low mass, low transverse and ground isolated; CE compliant	High sensitivity, low noise; triaxial cube, ground isolated; (3) 10-32 threaded mounting holes
Application	Modal analysis or structural testing	Modal analysis, automotive bodies and aircraft structures, general vibrations
Accessories	Cable: Type 1734A...K04 Coupler: Type 5100 series Ground isolated mounting clip: Type 800M155... Ground isolated adh. mounting base: Type 800M157 Ground isolated magnetic mounting base: Type 800M159	Cable: Types 1756C, 1734A... Extension cable: Type 1578A Isolated mounting stud: Type 8400K07 Coupler: Type 5100 series
Versions	...T: TEDS option (see p. 69)	...T: TEDS option (see p. 69)

General vibration

IEPE accelerometers – triaxial

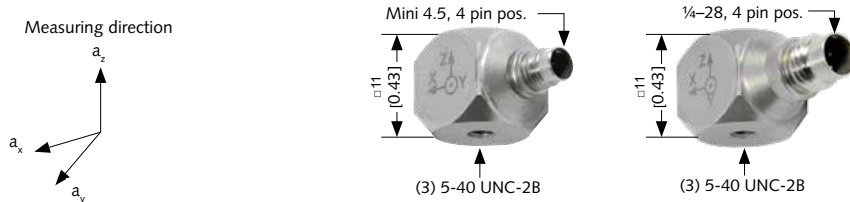

Type 8763...							
Technical data / Type		...B050	...B100	...B250	...B500	...B1K0A...	...B2K0A...
Range	g	±50	±100	±250	±500	±1 000	±2 000
Sensitivity, ±15%	mV/g	100	50	20	10	5	2.5
Frequency response, ±5%	Hz	0.5 ... 7 000		1 ... 10 000			
Resonance frequency mounted (nom.)	kHz	>35		>55			
Threshold	mg _{rms}	0.4	0.6	1	2	3	4.5
Transverse sensitivity	%	2.5					
Non-linearity	%FSO	±1					
Shock (1 ms pulse)	g _{pk}	5 000					
Temp. coeff. sensitivity	%/°C [%/°F]	0.01 [0.005]		-0.04 [-0.02]		0.02 [0.01]	
Operating temp. range	°C [°F]	-55 ... 100 [-65 ... 212]		-55 ... 120 [-65 ... 250]			
Power supply current	mA	2 ... 18					
Power supply voltage	VDC	22 ... 30					
Connector	type	Mini 4.5, 4 pin pos. (Type 8763B...A), 1/4-28, 4 pin pos. (Type 8763B...B)					
Housing/base	material	Titanium					
Sealing	type	Hermetic (...CBsp option: IP68 (waterproof) tested at 16 bar for 48 hours)					
Mass	grams	4.5 (Type 8763B...A) 5 (Type 8763B...B)		3.6 (Type 8763B...A) 4.1 (Type 8763B...B)		3.6	
Ground isolated		with pad					
Data sheet		8763B_000-928					

Properties	Mini cube design, (3) 5-40 thread holes, low mass, mini 4 pin connector, ceramic element; CE compliant
Application	Dynamic vibration, shock measurement, lightweight structures including automotive and aerospace R&D
Accessories	Cable: Types 1784B...K03, 1756C, 1734A Coupler: Type 5100 series Adhesive Mounting pad: Type 8434, ground isolated Mounting stud: Type 8400K04, ground isolated 5-40 stud to M6 stud Mounting stud: Type 8400K06, ground isolated 5-40 stud to 10-32 stud Mounting stud: Type 8440K01, adhesive mounted, ground isolated, 5-40 stud Magnetic mounting base: Type 8450A
Versions	...T: TEDS option (see p. 69) ...BxAx: M4.5, 4 pin pos. ...BxBx: 1/4-28, 4 pin pos. ...CBsp: Integral cable IP68 (waterproof)

General vibration

IEPE accelerometers – triaxial

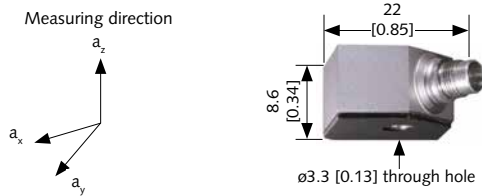

Type 8764...							
Technical data / Type		...B050...	...B100...	...B250...	...B500...	...B1K0...	...B2K0...
Range	g	±50	±100	±250	±500	±1 000	±2 000
Sensitivity, ±15%	mV/g	100	50	20	10	5	2.5
Frequency response, ±5%	Hz	0.5 ... 10 000		1... 10 000	1... 10 000	1... 10 000	1... 10 000
Resonance frequency mounted (nom.)	kHz	>50		>55	>55	>55	>55
Threshold	mg _{rms}	<0.4	<0.6	1.5	2.5	3.5	4.5
Transverse sensitivity	%	2.5					
Amplitude linearity	%FSO	±1					
Shock (1 ms pulse)	g _{pk}	5 000					
Temp. coeff. sensitivity	%/°C [%/°F]	0.01 [0.005]					
Operating temp. range	°C [°F]	-54 ... 100 [-65 ... 212]					
Power supply current	mA	2 ... 18					
Power supply voltage	VDC	22 ... 30					
Connector	type	Mini 4.5, 4 pin pos. (Type 8764BxAx); ¼-28, 4 pin pos. (Type 8764BxBx)					
Housing/base	material	Titanium	Titanium	Titanium	Titanium	Titanium	Titanium
Sealing	type	Hermetic	Hermetic	Hermetic	Hermetic	Hermetic	Hermetic
Mass	grams	5.9 (...AB); 6.1 (...BB) 6.0 (...AT); 6.2 (...BT)		4.9 (...AB); 5.0 (...AT) 5.1 (...BB); 5.3 (...BT)		4.9 (...AB) 5.0 (...AT)	
Ground isolated		yes	yes	yes	yes	yes	yes
Data sheet		8764B_003-201					

Properties	Low mass, easy connector orientation; M4.5 or ¼-28 connector options; hermetic titanium construction, low base strain sensitivity; ground isolated, TEDS options; CE compliant
Application	Well-suited for many applications where space is limited (NVH/durability testing, space/aerospace testing, vibration testing of subsystems)
Accessories	Adhesive mounting base: Types 8462K01, 8462K02 Cable: Types 1784B...K03, 1756C, 1734A Coupler: Type 5100 series
Versions	...T: TEDS option (see p. 69) ...BxAx: M4.5, 4 pin pos. ...BxBx: ¼-28, 4 pin pos. (not available for ...1K0... or ...2K0...)

General vibration

IEPE accelerometers – triaxial

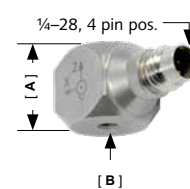
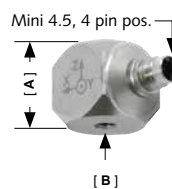
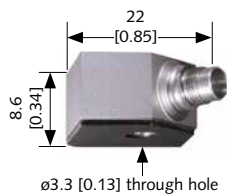
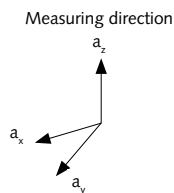

		Type 8765...			Type 8766...		
Technical data / Type		...A250M5	...A050	...A100	...A250	...A500	...A1K0A...
Range	g	±250	±50	±100	±250	±500	±1 000
Sensitivity, ±5%	mV/g	20	100	50	20	10	5
Frequency response, ±5%	Hz	1 ... 9 000	1 ... 6 000	1 ... 10 000	0.5 ... 10 000		1 ... 12 000
Resonance frequency mounted (nom.)	kHz	>50	>20	>30	>55	>55	>55
Threshold	mg _{rms}	2	2	4	6	10	20
Transverse sensitivity	%	2.5	1.5	1.5	1.5		
Non-linearity	%FSO	±1	±1	±1	±1		
Shock (1 ms pulse)	g _{pk}	5 000	5 000	5 000	5 000		
Temp. coeff. sensitivity	%/°C [%/°F]	-0.004 [-0.002]	-0.006 [-0.003]	0.002 [0.001]	-0.005 [-0.003]	-0.004 [-0.002]	-0.01 [-0.005]
Operating temp. range	°C [°F]	-55 ... 165 [-65 ... 330]	-55 ... 165 [-65 ... 330]				
Power supply current	mA	2 ... 20	2 ... 20	2 ... 20	2 ... 18		
Power supply voltage	VDC	18 ... 30	18 ... 30	18 ... 30	20 ... 30		
Connector	type	M4.5, 4 pin pos.	Mini 4.5, 4 pin pos. (Type 8766A...A), ¼-28, 4 pin pos. (Type 8766A...B)				Mini 4.5, 4 pin pos.
Housing/base	material	Titanium					
Sealing	type	Hermetic	Hermetic (...CBsp option: IP68 (waterproof) tested at 16 bar for 48 hours)				
Mass	grams	6.4	7	7	4	4	4
Dimensions	mm [in]	12.5 [0.49] (3) 6-32 UNC-2B			10.9 [0.43] (3) 5-40 UNC-2B		
[A]	thread						
[B]							
Ground isolated		yes		with pad			
Data sheet		8765A_000-472			8766A_000-607		

Properties	PiezoStar ultra-low thermal sensitivity variation, hermetic, ground isolated, mini 4 pin connector; CE compliant	PiezoStar element, 165°C [330°F] operation, TEDS, hermetic, titanium construction, low temperature and base strain sensitivity, low impedance voltage output; CE compliant
Application	Modal analysis, automotive and aircraft structures with dynamic temperatures	Applications include automotive under the hood and under the vehicle testing, as well as subsystem vibration testing for aerospace applications
Accessories	Adhesive mounting base: Types 8462K01, 8462K02 Cable: Types 1784BK03, Coupler: Type 5100 series	Cable: Types 1734A, 1756C, 1784B...K03 Coupler: Type 5165A series, 5100 series Mounting stud: Type 8400K02, ground isolated 6-32 stud to 10-32 stud Type 8400K04, ground isolated 5-40 stud to M6 stud Type 8400K05, ground isolated 6-32 stud to M6 stud Type 8400K06, ground isolated 5-40 stud to 10-32 stud Type 8440K01, adhesive, ground isolated, 5-40 base (Types 8766A250/500/1K0) Type 8452, magnetic mounting base, 10-32 thread Type 8440K04, adhesive, ground isolated, 6-32 base (Types 8766A050/100)
Versions		...AxAx: M4.5, 4 pin pos. ...AxBx: ¼-28, 4 pin pos. ...H: high temp. 165°C [330°F] ...T: TEDS option (see p. 69) ...CBsp: Integral cable IP68 (waterproof)

General vibration

IEPE accelerometers – triaxial

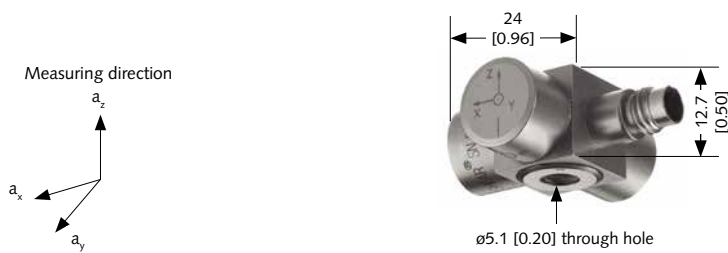

Type 8792...					
Technical data / Type		...A25	...A50	...A100	...A500
Range	g	±25	±50	±100	±500
Sensitivity, ±5%	mV/g	200	100	50	10
Frequency response, ±5%	Hz	1 ... 5 000	0.5 ... 5 000		1 ... 5 000
Resonance frequency mounted (nom.)	kHz	>54			
Threshold	mg _{rms}	2	4	6	10
Transverse sensitivity	%	1.5			
Non-linearity	%FSO	±1			
Shock (1 ms pulse)	g _{pk}	2 000			5 000
Temp. coeff. sensitivity	%/°C [%/°F]	-0.06 [-0.03]			
Operating temp. range	°C [°F]	-55 ... 100 [-65 ... 210]			-55 ... 120 [-65 ... 250]
Power supply current	mA	2 ... 20			
Power supply voltage	VDC	20 ... 30			
Connector	type	4 pin pos.			
Housing/base	material	Stainless steel			
Sealing	type	Hermetic			
Mass	grams	29			27
Ground isolated		yes			
Data sheet		8792A_000-260			

Properties	Center hole quartz shear triaxial, low base strain sensitivity; wide frequency range; ground isolated; low profile; CE compliant
Application	Center hole mounting capability allows orientation of exit cable or axis alignment; low profile package accommodates restricted space environments
Accessories	Socket cap screw: 10-32 x 0.75, M5x20 mm Cable: Types 1578A, 1756C Coupler: Type 5100 series
Versions	...T: TEDS option (see p. 69)

General vibration

IEPE accelerometers – triaxial

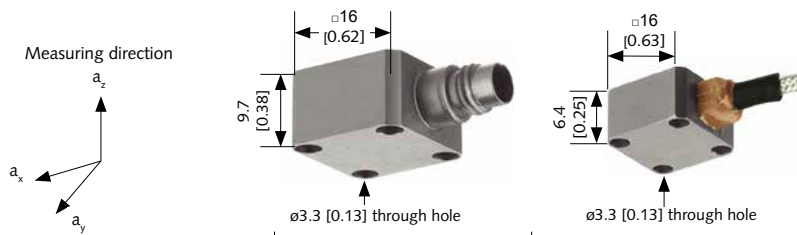

		Type 8793...	Type 8794...
Technical data / Type		...A500	...A500
Range	g	±500	±500
Sensitivity, ±5%	mV/g	10	10
Frequency response, ±5%	Hz	2.5 ... 10 000	2.5 ... 10 000
Resonance frequency mounted (nom.)	kHz	>80	>80
Threshold	mg _{rms}	2	2
Transverse sensitivity	%	1.5	1.5
Non-linearity	%FSO	±1	±1
Shock (1 ms pulse)	g _{pk}	5 000	5 000
Temp. coeff. sensitivity	%/°C [%/°F]	-0.03 [-0.02]	-0.03 [-0.02]
Operating temp. range	°C [°F]	-195 ... 165 [-320 ... 330]	-75 ... 165 [-100 ... 330]
Power supply current	mA	2 ... 18	2 ... 18
Power supply voltage	VDC	20 ... 30	20 ... 30
Connector	type	4 pin pos.	4 pin pos.
Housing/base	material	Stainless steel	Stainless steel
Sealing	type	Hermetic	Welded/Epoxy
Mass	grams	11	7.6
Ground isolated		with pad	yes
Data sheet		8793A_000-261	8794A_000-263

Properties	Low profile design, quartz shear stability, hermetically sealed; CE compliant	Low profile design, quartz shear stability, 2 m integral cable; CE compliant
Application	Useful for measuring vibration and shock on small and lightweight structures, extreme temperature applications	Low profile design provides an aerodynamic advantage for in-flight flutter testing, as well as general shock and vibration
Accessories	Cap screws 4-40 x 1/2, M2.5x12 mm Cable: Types 1756C, 1734A Coupler: Type 5100 series Mounting pad: Type 800M144	Cable: Types 1756C, 1734A Extension cable: Type 1578A Coupler: Type 5100 series Mounting screw: 4-40 x 3/8" and M2.5x10 mm Mounting pad: Type 800M144
Versions	...T: TEDS option (see p. 69) ...M5: high temp. (330 °F) ...M8: cryo temp. (-320 °F)	...M5: high temp. (330 °F)

Shock sensors

IEPE accelerometers – single-axis

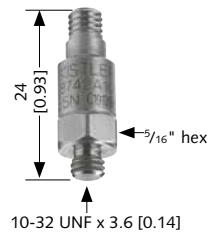
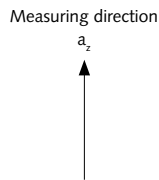

		Type 8742...				Type 8743...			
Technical data / Type		...A5	...A10	...A20	...A50	...A5	...A10	...A20	...A50
Range	g	±5 000	±10 000	±20 000	±50 000	±5 000	±10 000	±20 000	±50 000
Sensitivity, ±5%	mV/g	1	0.5	0.25	0.1	1	0.5	0.25	0.1
Frequency response	Hz	1 ... 10,000 (±7%)				1 ... 10,000 (±7%)			
Resonance frequency mounted (nom.)	kHz	>100				>100			
Threshold	mg _{rms}	130	250	500	1 300	130	250	500	1 300
Transverse sensitivity	%	1.5				1.5			
Non-linearity	%FSO	±1				±1			
Shock (1 ms pulse)	g _{pk}	50 000	50 000	50 000	100 000	50 000			100 000
Temp. coeff. sensitivity	%/°C [%/°F]	-0.06 [-0.03]				-0.06 [-0.03]			
Operating temp. range	°C [°F]	-55 ... 120 [-65 ... 250]				-55 ... 120 [-65 ... 250]			
Power supply current	mA	2 ... 20				2 ... 20			
Power supply voltage	VDC	18 ... 30				18 ... 30			
Connector	type	10-32 neg.				10-32 neg.			
Housing/base	material	Titanium/Stainless steel				Stainless steel			
Sealing	type	Hermetic				Hermetic			
Mass	grams	4.5				4.5			
Ground isolated		with pad				with pad			
Data sheet		8742A_000-250				8743A_000-564			

NOTE: For higher g range option, contact Kistler.

Properties	Unique quartz-shear sensing element, low transverse sensitivity, wide bandwidth, high resonant frequency; CE compliant
Application	Impact and vibration related applications, including shock and vehicle testing
Accessories	Cable: Types 1761B, 1761C Coupler: Type 5100 series

Modal analysis – force

Impedance head and charge force sensors

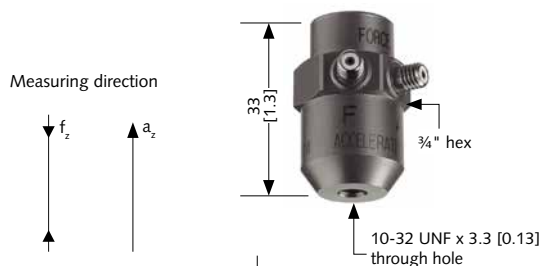

Type 8770...			
Technical data / Type		...A5	...A50
Acceleration			
Range	g	±5	±50
Sensitivity, ±10%	mV/g	1 000	100
Frequency response, ±5%	Hz	1 ... 4 000	
Resonance frequency mounted (nom.)	kHz	>16	
Threshold	mg _{rms}	0.4	1
Transverse sensitivity, typ.	%	1.5	1.5
Temp. coeff. sensitivity	%/°C [%/°F]	0.14 [0.08]	
Force			
Range	N [lbf]	±22 [±5]	±222 [±50]
Sensitivity, ±10%	mV/N [mV/lbf]	227 [1,000]	23 [100]
Threshold	N [lbf]	0.6 [0.00013]	6 [0.0013]
Temp. coeff. sensitivity	%/°C [%/°F]	0.05 [0.03]	
Operating temp. range	°C [°F]	-55 ... 80 [-65 ... 175]	-55 ... 120 [-65 ... 250]
Power supply	mA	2 ... 20	
	VDC	20 ... 30	
Connector	type	10-32 neg.	
Housing/base	type	Titanium	
Sealing	type	Hermetic	
Mass	grams	34	
Data sheet		8770A_000-252	

Properties	Low impedance voltage mode; sensitivity unaffected by mounting torque; wide frequency range; CE compliant
Application	Modal analysis, typically installed on a test article and connected by a threaded stinger to a shaker; measures input force and acceleration simultaneously
Accessories	Cable: Types 1761B, 1761C Coupler: Type 5100 series

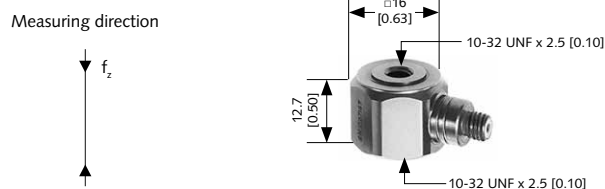

Type 9212		
Technical data		
Range compression	N [lbf]	22 000 [5 000]
Range tension	N [lbf]	2 200 [-500]
Threshold	N [lbf]	*
Sensitivity	pC/N [pC/lbf]	-11 [-50]
Non-linearity	%FSO	±1
Rigidity	kN/μm [lbf/μin]	>0.88 [>5]
Temp. coeff. sensitivity	%/°C [%/°F]	0.02 [0.01]
Operating temp. range	°C [°F]	-240 ... 150 [-400 ... 300]
Insulation resistance	Ω	10 ¹³
Capacitance	pF	58
Housing/base	material	Stainless steel
Sealing	type	Welded/Epoxy
Mass	grams	18
Data sheet		9212_000-418

Properties	High impedance, charge mode output, rugged quartz sensor; wide measuring ranges for compression and tension; quasi-static response
Application	Force applications, such as press-fit assembly, crimping and impact force testing; can be used with shakers for modal analysis, machine tool measurements or various automotive, aerospace and robotic testing
Accessories	Cable: Type 1631C Charge amp: Type 5000 series Impact mounting pad: Type 900A1

* Threshold depends on charge amplifier settings

Modal analysis – force

IEPE force sensors

Measuring direction

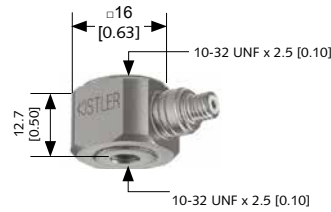

Type 9712...						
Technical data / Type		...B5	...B50	...B250	...B500	...B5000
Range compression	N [lbf]	22 [5]	220 [50]	1 100 [250]	2 200 [500]	22 000 [5 000]
Range tension	N [lbf]	-22 [-5]	-220 [-50]	-1 100 [-250]	-2 200 [-500]	-2 200 [-500]
Threshold	mN [lbf]	0.4 [0.0001]	4 [0.001]	20 [0.005]	40 [0.01]	400 [0.1]
Sensitivity	mV/N [mV/lbf]	180 [800]	22 [100]	4.5 [20]	2.25 [10]	0.225 [1]
Non-linearity	%FSO	±1				
Rigidity	kN/μm [lbf/μin]	>0.88 [>5]				
Temp. coeff. sensitivity	%/°C [%/°F]	0.036 [0.02]				
Operating temp. range	°C [°F]	-50 ... 120 [-60 ... 250]				
Power supply current	mA	4				
Power supply voltage	VDC	20 ... 32				
Connector	type	10-32 neg.				
Housing/base	material	Stainless steel				
Sealing	type	Hermetic				
Mass	grams	19				
Data sheet		9712_000-417				

Properties	Low impedance voltage mode, rugged quartz sensor; wide measuring range; uses standard low impedance cables; CE compliant
Application	Force applications where high sensitivity, high rigidity and fast response is required
Accessories	Cable: Types 1761B, 1761C Coupler: Type 5100 series Impact pad: Type 900A1

Modal analysis

IEPE Impulse hammers



		Type 9722...		Type 9724...		Type 9726...		Type 9728...
Technical data / Type		...A500	...A2000	...A2000	...A5000	...A5000	...A20000	...A20000
Force range	N [lbf]	0 ... 500 [0 ... 100]	0 ... 2 000 [0 ... 450]	0 ... 2 000 [0 ... 450]	0 ... 5 000 [0 ... 1,100]	0 ... 5 000 [0 ... 1,100]	0 ... 20 000 [0 ... 4,400]	0 ... 20 000 [0 ... 4,400]
Frequency response, -10 dB	Hz	8 200*	9 300*	6 600*	6 900*	5 000*	5 400*	1 000
Resonance frequency	kHz	27		27		27		20
Sensitivity	mV/N [mV/lbf]	10 [50]	2 [10]	2 [10]	1 [5]	1 [5]	0.2 [1]	0.2 [1]
Rigidity	kN/ μ m [lbf/ μ in]	0.8 [4.8]		0.8 [4.8]		0.8 [4.8]		2.56 [15.4]
Time constant	s	500		500		500		500
Operating temp. range	$^{\circ}$ C [$^{\circ}$ F]	-20 ... 70 [-5 ... 160]		-20 ... 70 [-5 ... 160]		-20 ... 70 [-5 ... 160]		-20 ... 70 [-5 ... 160]
Power supply current	mA	2 ... 20		2 ... 20		2 ... 20		2 ... 20
Power supply voltage	VDC	20 ... 30		20 ... 30		20 ... 30		20 ... 30
Connector	type	BNC neg.		BNC neg.		BNC neg.		BNC neg.
Length of handle	mm [in]	188 [7.4]		231 [9.1]		236 [9.3]		343 [13.5]
Hammer head: diameter	mm [in]	17.5 [0.69]		23 [0.9]		32 [1.25]		51 [2]
Hammer head: length	mm [in]	61 [2.4]		89 [3.5]		94 [3.7]		154 [6.1]
Mass	grams	100		250		500		1 500
Data sheet		9722A_000-272		9724A_000-273		9726A_000-274		9728A_000-275

Properties	Low impedance voltage mode, quartz force sensing element integrated to hammer head; CE compliant
Application	Modal analysis
Accessories	Cable: Type 1601B... Coupler: Type 5100 series

* Low frequency point depends upon the system time constant and tip in use; contact Kistler for details

Rotational accelerometers

Rotational accelerometers

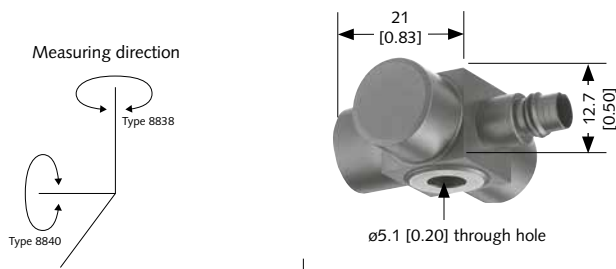

		Type 8838	Type 8840
Technical data			
Range	krads/s ²	±150	±150
Sensitivity, ±10%	µV/rad/s ²	35	35
Frequency response, ±5%	Hz	1 ... 2 000	1 ... 2 000
Resonance frequency mounted (nom.)	kHz	>23	>23
Threshold	rad/s ²	4	4
Transverse sensitivity	%	1.5	1.5
Non-linearity	%FSO	±1	±1
Shock (1 ms pulse)	g _{pk}	5 000	5 000
Temp. coeff. sensitivity	%/°C [%/°F]	0.06 [0.03]	0.06 [0.03]
Operating temp. range	°C [°F]	-55 ... 120 [-65 ... 250]	-55 ... 120 [-65 ... 250]
Power supply current	mA	4	4
Power supply voltage	VDC	20 ... 30	20 ... 30
Connector	type	4 pin pos.	4 pin pos.
Housing/base	material	Titanium	Titanium
Sealing	type	Hermetic	Hermetic
Mass	grams	18.5	18.5
Ground isolated		yes	yes
Data sheet		8838_000-271	8838_000-271

Properties	Shear quartz piezoelectric; axial oscillations; hermetic construction; lightweight and convenient through hole mount; CE compliant	
Application	Axial or shaft type measurements on an oscillating, non-rotating specimen	Lateral type measurements on an oscillating, non-rotating specimen
Accessories	Cable: Types 1592M1, 1578A, 1786C	

Acoustic emissions

Acoustic emission sensors/conditioning



Measuring direction
v_z

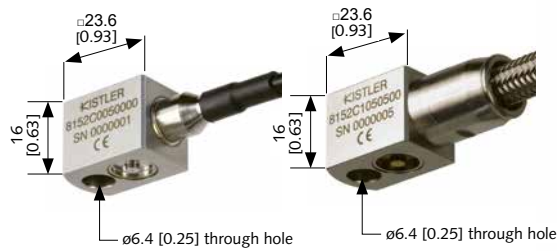

Type 8152...			
Technical data / Type		...C0...	...C1...
Frequency range	kHz	50 ... 400	100 ... 900
Sensitivity, nom.	dB _{ref 1 V (m/s)}	57	48
Shock (0.5 ms pulse)	g	2 000	
Operating temp. range	°C [°F]	-55 ... 165 [-65 ... 330]	
Transverse sensitivity	%	1.5	1.5
Supply: power supply	mA	3 ... 6	
Voltage (coupler)	VDC	5 ... 36	
Output voltage (full-scale)	V	±2	
Output bias	VDC	2.2	
Mass	grams	29	
Case	material	Stainless steel	
Sealing	type	Hermetic	
Ground isolated		yes	
Data sheet		8152C_003-120	

Type 5125C...		
Technical data		
Sensor excitation current	mA (±10%)	±4.3
Frequency response	kHz	Default: 50 ... 1 000
Output 1	mA	4 ... 20
Output 2	VDC RMS	0 ... 10
Output 3		Alarm Switch
Output 4	VAC, Raw AE	0±5
Gain		Default: 10 (adjustable by user = 1 or 100)
Power	VDC	18 ... 35
Operating temp. range	°C [°F]	-40 ... 80 [-40 ... 180]
Dimensions (WxHxD)	mm [in]	133x86x105 [5.24x3.38x4.13]
Connector	type	cable gland pigtail or conduit adaptor
Mass	grams	1 100
Data sheet		5125C_003-119 5125C_000-121

Properties	High sensitivity and wide frequency range, inherent high-pass characteristic, robust, suitable for industrial use (high temp., hermetically sealed, IS/ATEX options available), ground isolated, braided or non-braided integral cable available; CE compliant	
Application	Measurement of high energy surface waves above 50 kHz in the surface of metallic components, structures or systems. Detection of flow perturbation, leakage, plastic deformation of materials, crack formation, fracturing, friction and fatigue. Non-destructive testing, as well as permanent online monitoring of continuous processes for conditional and preventative maintenance. ATEX certifications option allows for usage in hazardous environments, such as processing industries applications where explosive gas and dust is always present.	
Accessories	Magnetic clamp: Type 8443B Wideband Zener Barrier : Type 5252A	
Versions	Type 8152Cxyy00... : PFA cable (yy = length in m) Type 8152Cxyyyy... : Braided cable (yy = length in m) Type 8152C.....0: Non-Intrinsically Safe Type 8152C.....1: Zone 0 Certification in Europe & N.A. Type 8152C.....2: Zone 2 Certification in Europe & N.A. Type 8852A... : Couple Acoustic Emission Measuring chain including user specified 8152C sensor and 5125C delivered with a test certificate.	Type 5125C0 / 1: Non-Intrinsically Safe Type 5125C0x0x: Zone 0 Certification in Europe & N.A. Type 5125C0x2x: Zone 2 Certification in Europe & N.A.

High temperature accelerometers

Measuring direction
v_z



		Type 8205B...			Type 8207A...	Type 8209A...	Type 8211A...
Technical data / Type		...1...	...2...	...3...			
Range	gpk	±250			±500	±500	±500
Sensitivity	pC/g	20±5%	50±5%	100±5%	10±3%	5±3%	5±3%
Frequency response, ±5%	Hz	1 ... 9 000	1 ... 8 000	1 ... 7 500	1 ... 4 000		
Resonant frequency (nom.)	kHz	30	28	25	>12		
Transverse sensitivity	%	<4			<2		
Non-linearity	% FSO	±1			<1		
Operating temp. range	°C [°F]	-55... 260 [-67... 500]			-55... 480 [-67... 896]	-55... 700 [-67... 1 292]	-55... 700 [-67... 1 292]
Housing/base	material	Stainless steel			INCONEL alloy 600		
Sealing	type	Hermetic (...E... option: IP68 (waterproof))			Hermetic (IP68 (waterproof))		
Mass	grams	50			75 (triangle) / 100 (square)		30
Data sheet		8205B_003-253			8207A_003-333	8209A_003-337	8211A_003-340

Properties	PiezoStar element, high temperature, high frequency response, CE compliant, ATEX / IECEx options available, integral cable options available	
Application	Thermoacoustics, harsh and high temperature environments, gas turbines, Ex potentially explosive environments	
Accessories	High temperature mounting screw: 8445AS1HT / 8445AS2HT Mounting screw: 8445AS1 / 8445AS2 Mounting adapter to 30x30mm hole pattern: 8433AS30 Mounting adapter for tubes: 8433AP20 Mounting bracket for hardline cable: 1423A1 High temperature thread paste: 1059 Softline cable: 1652A...	
Versions	8205BE...: Ex-ia; Ex-nA 8205B...B...: Integral cable IP54, pigtails 8205B...C...: Integral cable IP54, pigtails with steel overbraid 8205B...D...: Integral cable IP54, pigtails with spiral metal hose 8205B...E...: Integral cable IP68 (waterproof), pigtails with sealed metal hose	8207/09/11AE...: Ex-ia; Ex-nA 8207/09/A...1...: ARINC footprint 8207/09/A...2...: Square footprint 8207/09/11A...A...: Integral cable IP68 (waterproof), LEMO connector 8207/09/11A...B...: Integral cable IP68 (waterproof), 7/16-27 connector 8207/09/11A...C...: Integral cable IP68 (waterproof), pigtails

Electronics

IEPE sensor power supply



		Type 5108A	Type 5114	Type 5118B2
Technical data / Type		IEPE	IEPE	IEPE
Channels	number	1	1	1
Sensor excitation voltage	VDC	20	20	±5
Sensor excitation current	mA	4	2	2
Frequency response	Hz	0.02 ... 87 000	0.07 ... 60 000	0.02 ... 40 000
Output signal voltage	V	±10	±10	±10
Gain		1	1	1, 10, 100
Power		Banana Jacks (22 ... 30 VDC)	Battery: 9 V alkaline (IEC 6LR61)	4 x 1.5 V AA, alkaline
Operating temp. range	°C [°F]	0 ... 50 [32 ... 120]	-10 ... 55 [15 ... 130]	-20 ... 50 [-5 ... 125]
Dimensions (WxHxD)	mm [in]	96x43x28 [3.8x1.7x1.1]	81x150x36 [3.2x5.9x1.4]	97x48x180 [3.8x1.9x7]
Connector	type	Input: BNC neg. Output: BNC pos. Power: Banana Jacks, polarity (+ red, - black)	Input/Output: BNC neg.	Input/Output: BNC neg.
Mass	grams	64	250	500
Data sheet		5108A_000-328	5114_000-330	5118B_000-331
Properties		Simple to operate, AC coupled, reverse polarity protection; use with low impedance Piezotron sensors with built-in electronics; CE compliant	Provides constant current excitation, monitors condition of sensors and cables; 3.5" digital LCD display AC-DC or battery powered; CE compliant	Selectable gain and low-pass, plug-in filters, panel selectable, high-pass filtering, exclusive "Rapid Zero" feature AC-DC or battery powered; CE compliant
Application		Provide DC power to sensors that contain miniature impedance converting circuits and to couple the signal generated in each to an electronic measurement instrument	Power and monitor Piezotron low impedance sensors	Powering low impedance sensors where test conditions require flexible signal conditioning
Accessories		Cable: Types 1761B, 1761C	AC-DC power adapter: Type 5752	AC-DC power adapter: Type 5752 Panel mounting kit: Type 5702 Plug-in low-pass filters: Types 5326A..., 5327A...
Versions			Type 5114: 9 V alkaline battery Type 5114S1: 9 V alkaline battery, 115 VAC power adapter and carrying case Type 5114S1(E): as S1 with 230 VAC power adapter	

Electronics

IEPE sensor power supply



		Type 5148	Type 5127
Technical data / Type		IEPE	IEPE
Channels		16	1
Sensor excitation voltage	VDC	24	4
Sensor excitation current	mA	0 ... 750	0.1 ... 30 000
Frequency response	Hz	0.05 ... 50 000	0.1 ... 30 000
Output signal voltage	V	±10	±10
Gain		1	1, 10
Power	type	115/230 VAC	22 ... 30 V
Operating temp. range	°C [°F]	0 ... 50 [32 ... 120]	0 ... 60 [32 ... 140]
Dimensions (WxHxD)	mm [in]	425x45x221 [19x1.8x8.7]	115x64x35 [4.5x2.5x1.4]
Connector	type	Input/Output: 16 BNC neg.	Input: BNC neg. or cable strain relief Output: 8 pin round connector DIN 45326
Mass	kg	2.5	0.27
Data sheet		5148_000-333	5127B_000-323

Properties	Provides constant current excitation for Piezotron and voltage mode piezoelectric sensors; LED's indicate circuit integrity; convenient front/rear BNC connectors; standard rack mountable; CE compliant	Built-in RMS converter and limit monitor, plug-in filter modules, rugged case, vibration-proof construction; CE compliant
Application	Multi-channel, low impedance sensor power at economical price per channel	Vibration and acoustic emission (AE) sensors
Accessories	AC-DC power adapter: Type 5754	Plug-in, low/high-pass filters and rms time constant: Type 53xx 8 pin round connector: Type 1500A57 Power and signal cable: Type 1500A31
Versions		*request data sheet for all ordering options

Electronics

MEMS sensor power supply



		Type 5210	Type 5146A15
Technical data / Type		MEMS Capacitive	MEMS Capacitive
Channels		1	15
Compatible sensors			
Sensor excitation voltage	VDC	9	12 ±1
Sensor excitation current	mA	25	25
Output signal voltage	V	±8	±8
Gain		1, 2, 10, 20	1
Power	type	9 V Battery	100-240 VAC 50-60 Hz or +12 VDC
Operating temp. range	°C [°F]	-10 ... 55 [15 ... 130]	0 ... 40 [30 ... 105]
Dimensions (WxHxD)	mm [in]	147x91x33 [5.8x3.6x1.3]	425x88x305 [16.7x3.47x12]
Connector	type	Sensor: 4 pin, Microtech pos. Output signal: BNC neg. External DC input: 2.1 mm jack (tip +)	Sensor output: 30 BNC or 37 pin D-Sub Sensor input (Type 8316A...): 15 x 4 pin male ¼-28 Sensor input (Type 8396A...): 5 x DB9 female
Mass	kg	0.26	3.5
Data sheet		5210_000-334	5146A15_003-113

Properties	Adjustable offset control for higher resolution measurements, battery or external power, gain and filtering options; low battery indicator, complete kit available/ R&D; CE compliant	Provide interface between single-ended, differential, single-axis or triaxial output capacitive accelerometers and measuring instruments; 15-channel unit, operates with a power input over 100 ... 240 VAC or from another +12 VDC power source, such as a vehicle
Application	Power single-axis K-Beam accelerometer from a casual check to an in-depth study	Provides excitation power and serves as a junction box for capacitive accelerometer family Types 8316A... and 8396A...; rugged and universal unit; provides excellent portability to a vibration measurement system both in the laboratory and in the field
Accessories	AC-DC power adaptor: Type 5752	AC-DC power adaptor: Type 8752 DC power cable with pigtailed: Type 704-2068001
Versions	Type 5210: 9 V battery Type 5210S1: 9 V battery, 115 V power adaptor; Type 5752 and carrying case	

Electronics

Dual-mode charge amplifiers



		Type 5015A / 5018A	Type 5165A
Technical data / Type		Charge Amplifier	Dual Mode Charge/IEPE
Measuring range	pC	$\pm 2 \dots 2\,200\,000$	$\pm 100 \dots 1\,000\,000$
Channels		1	1 / 4
Frequency response (standard filter)	Hz	0 ... 200 000	0.1 ... 100 000
Output voltage	V	$\pm 2 \dots \pm 10$	0 ... ± 10
Output current	mA	2	2
Accuracy	%	$< \pm 0.5 \dots < \pm 3$	$< \pm 0.5 \dots < \pm 1$
Integrated Data Acquisition	kSps/Ch	no	up to 200
Power		115/230 VAC	18 ... 30 VDC
Operating temp. range	°C [°F]	0 ... 50 [32 ... 122]	0 ... 60 [32 ... 140]
Remote control	type	6 pin; DIN 45322 RS-232C: 9 pin D-Sub	Ethernet (RJ45 connector)
Dimensions (LxWxH)	mm [in]	250x105x142 [9.9x4.1x5.6] (with case)	223x218x51 [8.8x8.6x2.0]
Connector	type	Input/Output: BNC neg.	Input/Output: BNC neg.
Mass	kg	≈ 2.3	≈ 1.2
Data sheet		5015A_000-297; 5018A_000-719	5165A_003-146

Properties	Single-channel charge amplifier, LCD menu, real-time display of measured value, optional Piezotron input; CE compliant		For high and low impedance sensors; communication via Ethernet; configuration via web-interface; integrated data acquisition; front panel LEDs for status indication of each input and output; digital high-pass, low-pass and notch filters; TEDS compatible; CE compliant
Application	Measure dynamic pressure, force, strain and acceleration from piezoelectric sensors		General vibration lab/R&D use with single-axis or triaxial accelerometers; measure dynamic pressure, force, strain and acceleration from piezoelectric sensors
Accessories			AC-DC Power adapter: Type 5779A2 19" rack mounting tablet: Type 5748A1
Versions	Type 5015A1... : with case Type 5015Ax1: with IEEE interface Type 5015Axxx1: with Piezotron (IEPE)	Type 5018A1... : with case Type 5018Axxx2 : with Piezotron (IEPE)	1-Channel: Type 5165A1 4-Channels: Type 5165A4

Electronics

In-line IEPE signal conditioning



Type 5050B...						
Technical data / Type		...B0.1 / 0.1T	...B0.5 / 0.5T	...B1 / 1T	...B10 / 10T	...B25 / 25T
Output signal voltage	V _{pp}	10				10
Gain	mV/pC	0.1	0.5	1	10	25
Noise (broadband 1 ... 10 kHz)	μV _{rms}	5	5	5	15	35
Input resistance min.	kΩ	100				
Input capacitance	pF	30 000				
Frequency response, -5%	Hz	0.5 ... 50 000	0.5 ... 50 000	0.5 ... 50 000	2 ... 50 000	5 ... 50 000
Constant current	mA	2 ... 18				
Compliance voltage	VDC	20 ... 30				
Operating temp. range	°C [°F]	-55 ... 65 [-65 ... 150]				
Signal polarity		inverted				
Sealing	type	Welded/Epoxy				
Housing/base	material	Stainless steel				
Mounting	type	in-line				
Input connector	type	10-32 neg.				
Output connector	type	BNC neg.				
Mass	grams	28				
Data sheet		5050B_003-073				

Properties	Two-wire, single-ended charge converter; rugged, stainless steel case; wide frequency response; 3 gain versions; ideal for ceramic high impedance accelerometers; TEDS option available; CE compliant
Application	In-line charge converter for high impedance ceramic accelerometers; ideal for remote signal conditioning for high temperature vibration measurements
Accessories	Cable: Type 1635C... (input), Type 1511B (output) Coupler: Type 5100 series
Versions	TEDS: Type 5050B...T (see p.67)

Calibration and test equipment

IEPE/voltage and charge output sensors

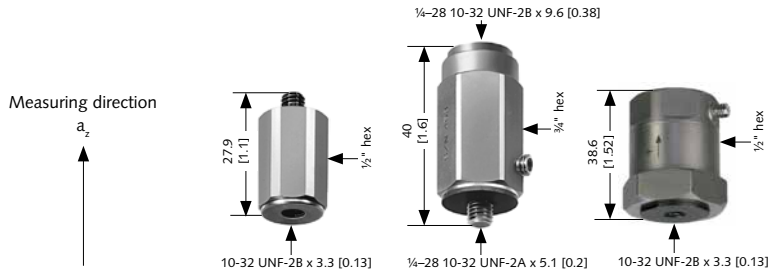

		Type 8002K	Type 8076K	Type 8080A050...
Technical data		Charge Mode	Charge Mode	IEPE/Voltage Mode
Range	g	±1 000	±1 000	50
Sensitivity, ±0.1	pC/g mV/g	-1	1	100
Frequency response	Hz	≈0 ... 6 000 (-1, ±5%)	0.5 ... 5 000 (±4%)	0.5 ... 10 000 (±5%)
Resonance frequency mounted (nom.)	kHz	>40	>33	>20
Threshold	mg _{rms}	20	10	5
Transverse sensitivity	%	≤2	≤2	≤3
Non-linearity	%FSO	±0.5	±0.5	≤1
Temp. coeff. sensitivity	%/°C [%/°F]	-0.03 [-0.02]	0.02 [0.01]	-0.05 [-0.03]
Operating temp. range	°C [°F]	-70 ... 120 [-95 ... 250]	-20 ... 65 [-5 ... 150]	-55 ... 100 [-65 ... 210]
Connector	type	10-32 neg.	10-32 neg.	10-32 neg.
Housing/base	material	Stainless steel	Stainless steel	Stainless steel
Sealing	type	Epoxy	Epoxy	Hermetic
Mass	grams	20	80	175
Sensing element	type	Quartz	Quartz	PiezoStar
Data sheet		8002_000-205	8076K_000-210	8080A050_003-171
Properties		High impedance charge mode, quartz stability and repeatability, with wide operating temperature; CE compliant	High impedance charge mode, quartz accuracy and stability, rugged design, low base strain sensitivity, ground isolated; CE compliant	High thermal stability, low base strain, long-term stability, high frequency response, minimum sensitivity to rocking motion, ground isolated; CE compliant
Application		Used as calibration primary standard	Used as back-to-back calibration transfer standard	Transfer standard for back-to-back calibration of accelerometers; ideal for field calibrations
Accessories		Mounting stud: Type 8402 Cable: Type 1631C	Mounting stud: Type 8410 Cable: Type 1631C	Mounting stud: Types 8412, 8421, 8410, 8414, 8406 Cable: Type 1761B... Series Coupler: Type 51...
Versions				...A: 1/4-28 UUT mounting thread ...B: 10-32 UUT mounting thread

Calibration and test equipment

Reference shakers, insulation tester and HSU-nielsen test kit



Type 8921B...			
Technical data / Type		8921B01	8921B02
Reference frequency	Hz	159.2	selectable: 15.92 ... 1 280
Amplitude			selectable:
Acceleration _{rms} ±3%	g	1	0.102 ... 2.039
Velocity _{rms} ±3%	mm/s	10	1 ... 20
Displacement _{rms} ±3%	µm	10	1 ... 200
Maximum load	grams	600	500
Operating temp. range	°C [°F]	-10 ... 55 [14 ... 130]	-10 ... 55 [14 ... 130]
Operating time	hours	5	5
Power supply		built-in battery; rechargeable	built-in battery; rechargeable
Battery charger			
Input voltage	VAC Hz	100 ... 240 50/60	100 ... 240 50/60
Output voltage	VDC	11 ... 18	11 ... 18
Output current	A	<1	<1
Dimensions (HxWxD)	mm [in]	100x100x120 [3.9x3.9x4.7]	100x100x120 [3.9x3.9x4.7]
Data sheet		8921B_003-090	8921B_003-090

Properties	Test measurement system integrity; convenient self-contained and portable; rechargeable battery; tests sensors up to 500 grams; CE compliant; Type 8921B02 has selectable reference frequency and amplitudes
Application	The Type 8921B... reference shaker can be used to confirm sensitivity of acceleration, velocity and displacement sensors.
Accessories	Stud 10-32 to M5, Type 8451 Stud ¼-28 to M5, Type 8453
Versions	With power plug 110 ... 230 VAC

Type 5493		
Technical data		
Number of channels		1
Measuring ranges FS	Ω	10 ¹¹ ... 4x10 ¹³
Measuring voltage	V	5
Max. parallel capacitance (cable length)	nF nF	10 100
Measurement display		logarithmic
Power supply (battery)	VDC	9
Input signal	type/ connector	BNC neg.
Dimensions (LxWxH)	mm [in]	36x81x150 [1.4x3.2x5.9]
Mass	grams	290
Degree of protection to IEC / EN 60529		IP50
Data sheet		5493_000-354

Properties	Small, robust service device for measuring high insulation resistance on the spot; low measuring voltage of 5 V, logarithmic indication avoids the need for range switching, automatic switch-off; CE compliant
Application	Battery-powered tester ideal for routine and field checking of piezoelectric sensors, charge amplifiers and cables



Type KIG-4930A	
Technical data	
Contains:	2 pencils with 0.35 mm and 0.5 mm; 2 H leads with specific plastic tip adaptor
Application	Generating a sharp pulse of low amplitude according to HSU-Nielson Test per ASTM Std. E976; allows for calibration of acoustic emission sensors or for resonance frequency determination of a mounted acceleration sensor

Accessories

Mounting

Common accessories extend the flexibility of the accelerometer families, often adapting to less than optimal conditions. For instance, the variety of adhesive mounting pads provide ground isolation while permitting a reasonable attachment in situations where tapping a threaded hole is unacceptable.

A series of magnet mounts provide an alternate solution if the structure is a ferrous material. Also included in this section are a variety of conversion studs to accommodate a previous mounting site to a different accelerometer with different threads. Mounting

cubes provide a means of obtaining accurate orthogonal measurements at a reasonable cost.

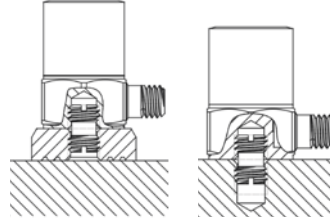

Magnetic mounting base – see data sheet 8400_000-281 for more information

Technical data	Type	A mm [in]	B mm [in]	C mm [in]	THD. X	Holding Force N [lbf]	Weight (grams)	Max. temp. °C [°F]	Material	Recommended Sensor Types
	8450A	7.6 [0.30]	12.7 [0.50]	11.1 [0.44]	5-40	26.7 [6]	1.25	170 [340]	17-4 PH Stainless steel	8763, 8730
	8452A	11.2 [0.44]	17.8 [0.70]	15.9 [0.62]	10-32	55 [12]	19	260 [500]	17-4 PH Stainless steel	8274, 8702, 8703, 8704, 8705, 8774, 8784, 8763, 8202, 8786, 8290, 8766
	KIG4662B-4	10.9 [0.43]	18.0 [0.71]	12.7 [0.50]	10-32	55 [12]	17	80 [175]	Stainless steel	
	KIG4662B-1	10.9 [0.43]	18.0 [0.71]	12.7 [0.50]	6-32	55 [12]	17	80 [175]	Stainless steel	8714
	KIG4662B-5	9.9 [0.39]	11.9 [0.47]	9.9 [0.39]	M2.5	55 [12]	8	80 [175]	Stainless steel	8765, 8715, 8764
	KIG4662B-6	5.8 [0.23]	9.4 [0.37]	7.1 [0.28]	5-40	20 [5]	8	80 [175]	Stainless steel	8730, 8640
	8456	11.3 [0.44]	25.0 [0.98]	-	¼-28	135 [30]	57	170 [340]	17-4 PH Stainless steel	8203
	KIG4662B-3	14.0 [0.55]	18.0 [0.71]	-	10-32	50 [11]	16	80 [180]	Stainless steel	8702, 8705
	KIG4662B-2	14.0 [0.55]	18.0 [0.71]	-	¼-28	50 [11]	16	80 [180]	Stainless steel	-
	8458A	28.0 [1.10]	47.0 [1.85]	-	¼-28	40 [9]	102	-	17-4 PH Stainless steel	8203, 8712

Technical data	Type	A mm [in]	C mm [in]	D mm [in]	THD. X	Holding Force N [lbf]	Material	Recommended Sensor Types
	8466K03	5.08 [0.20]	8.9 [0.35]	22.2 Hex [0.88 Hex]	10-32	100 [22]	303 Stainless steel	8396
	800M159	2.5 [0.10]	6.3 [0.25]	11.1 [0.44]	10-32	40 [9]	17-4 PH Stainless steel	8688
	800M160	2.5 [0.10]	5.1 [0.20]	9.4 [0.37]	5-40	30 [7]	17-4 PH Stainless steel	8640



Accessories

Mounting

Magnetic mounting base – see data sheet 8400_000-281 for more information

Technical data	Type	A (thickness) mm [in]	B mm [in]	C mm [in]	THD. X	Holding Force N [lbf]	Material	Recommended Sensor Types
	8464K03	7.6 [0.30]	21.6 [0.85]	25.4 [1.00]	4–40	100 [22]	17-4 PH Stainless steel	8316

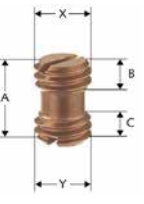
Mounting studs – see data sheet 8400_000-281 for more information

Technical data	Type	A mm [in]	B mm [in]	C mm [in]	THD. X	THD. Y	Material	Recommended Sensor Types
	8402	7.1 [0.28]	2.5 [0.10]	2.5 [0.10]	10–32	10–32	BeCu	8290, 8202, 8702, 8704, 8703, 8705, 8784, 8786, 8396, 8762, 8770
	8404	7.1 [0.28]	2.5 [0.10]	2.5 [0.10]	10–32	10–32	17-4 PH Stainless steel	8044
	8406	5.8 [0.23]	2.0 [0.08]	2.0 [0.08]	10–32	10–32	BeCu	8076K, 8080
	8410	6.4 [0.25]	3.2 [0.13]	2.0 [0.08]	¼–28	10–32	BeCu	8076K, 8203, 8712, 8784, 8786, 8080
	8411	10.4 [0.41]	6.6 [0.26]	2.8 [0.11]	M6	10–32	BeCu	8290, 8202, 8702, 8704, 8703, 8705, 8784, 8786, 8762, 8770, 8002K
	8416	6.6 [0.26]	3.2 [0.13]	2.3 [0.09]	10–32	5–40	316 Stainless steel	8763, 8766A250/500/1K0
	8416K01	7.1 [0.28]	3.2 [0.12]	2.5 [0.10]	5–40	M3	303 Stainless steel	–
	8418	7.0 [0.28]	3.8 [0.15]	2.3 [0.09]	M6	5–40	316 Stainless steel	8763, 8766A250/500/1K0
	8421	12.3 [0.48]	7.5 [0.30]	3.3 [0.13]	M8	¼–28	BeCu	8203, 8712, 8080
	8430K03	6.9 [0.27]	3.6 [0.14]	2.3 [0.09]	10–32	6–32	BeCu	8766A50, 8766A050/100
	8451	8.8 [0.34]	5.0 [0.20]	2.8 [0.11]	M5	10–32	BeCu	8688, 8290, 8202, 8702, 8704, 8703, 8705, 8762, 8784, 8786, 8770, 8002K
8453	9.8 [0.38]	5.1 [0.20]	3.7 [0.15]	M5	¼–28	BeCu	8712	

Accessories

Mounting

Stud converters – see data sheet 8400_000-281 for more information

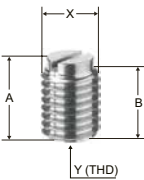
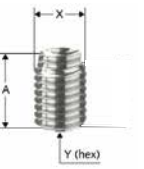
Technical data	Type	A mm [in]	B mm [in]	THD. X	THD. Y	Material	Recommended Sensor Types
	8414	8.9 [0.35]	7.1 [0.28]	¼–28	10–32	17-4 PH Stainless steel	8076K, 8080
	8484	5.5 [0.21]	3.4 [0.13]	10–32	5–40	17-4 PH Stainless steel	
	8486	5.5 [0.21]	3.4 [0.13]	10–32	M3	17-4 PH Stainless steel	
	8412	9.5 [0.37]	–	¼–28	Hex	18-8 Stainless steel	8712, 8076K, 8080
	8420	6.3 [0.25]	–	5–40	Hex	18-8 Stainless steel	8763

Triaxial mounting cubes and adhesive mounting clips – see data sheet 8400_000-281 for more information

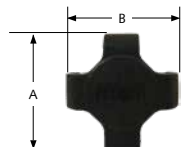
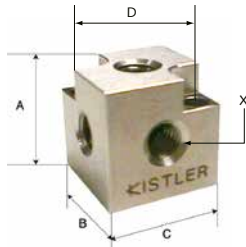
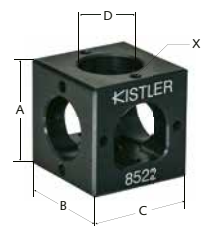
Technical data	Type	A mm [in]	B mm [in]	C mm [in]	D mm [in]	THD. X	Weight (grams)	Material	Recommended Sensor Types
Mounting Clips 	800M156	16.3 [0.64]	16.0 [0.63]	–	–	–	–	Polycarbonate	8640
	800M155	20.1 [0.79]	19.8 [0.78]	–	–	–	–	Polycarbonate	8688
Triaxial Mounting Cubes 	8502	25.4 [1.00]	25.4 [1.00]	25.4 [1.00]	25.4 [1.00]	10–32	117	303 Stainless steel	8202, 8702, 8703, 8704, 8705, 8002K
	8504	14.5 [0.57]	14.5 [0.57]	14.5 [0.57]	14.2 [0.56]	10–32	20	303 Stainless steel	8044, 8742, 8743
	8510	14.3 [0.57]	14.3 [0.57]	14.3 [0.57]	14.2 [0.56]	5–40	19	316 Stainless steel	8730
	8514	17.3 [0.68]	17.3 [0.68]	17.3 [0.68]	18.4 [0.72]	10–32	35	303 Stainless steel	8202, 8702, 8704, 8774
	8524	11.1 [0.44]	11.1 [0.44]	11.1 [0.44]	–	10–32	2.8	Al. hard anodized	8774, 8274 (stud mount)
	8522	27.0 [1.06]	27.0 [1.06]	27.0 [1.06]	15.1 [0.59]	4–40	28	Al. hard anodized	8316

Accessories

Mounting

Isolated mounting pads – see data sheet 8400_000-281 for more information

Technical data	Type	A mm [in]	B mm [in]	C mm [in]	D mm [in]	THD. X	THD. Y	Material	Recommended Sensor Types
	8434	4.8 [0.19]	2.4 [0.49]	11.1 [0.44]	–	5–40	–	Al. hard anodized	8730, 8763
	8436	4.8 [0.19]	15.7 [0.62]	14.2 [0.56]	–	10–32	–	Al. hard anodized	8202, 8203, 8274, 8702, 8703, 8704, 8705, 8774, 8784, 8786, 8766
	8438	7.9 [0.31]	21.0 [0.83]	19.1 [0.75]	–	¼–28	–	Al. hard anodized	8076K
	8442	9.5 [0.37]	18.3 [0.72]	–	–	¼–28	–	Al. hard anodized	–
	8436M02	3.0 [0.12]	9.0 [0.35]	8.0 [0.31]	–	5-40	–	Al. hard anodized	8730
	8462K01	4.8 [0.19]	20.5 [0.81]	19.0 [0.75]	–	4-40	–	Al. hard anodized	8764, 8765, 8715
	8462K02	4.8 [0.19]	20.5 [0.81]	19.0 [0.75]	–	M2.5	–	Al. hard anodized	8764, 8765, 8715
	800M157	2.5 [0.10]	–	6.4 [0.25]	11.1 [0.44]	10–32	–	Al. hard anodized	8688
	800M158	2.5 [0.10]	–	5.1 [0.20]	9.4 [0.37]	5–40	–	Al. hard anodized	8640
	8440K01	5.2 [0.20]	–	8.0 [0.31]	12.7 Hex [0.50]	5–40	–	Al. hard anodized	8763A, 8766A250/ 500/1K0
	8440K02	5.7 [0.22]	–	9.0 [0.35]	19.1 Hex [0.75]	6-32	–	Al. hard anodized	8766A50
	8440K03	5.0 [0.19]	–	8.3 [0.32]	14.3 Hex [0.56]	10–32	–	Al. hard anodized	8702, 8703, 8704, 8705
	8440K04	5.0 [0.19]	–	8.3 [0.32]	14.3 Hex [0.56]	6–32	–	Al. hard anodized	8766A050/100
	8466K01	6.4 [0.25]	–	10.2 [0.40]	22.2 Hex [0.87]	10–32	–	Al. hard anodized	8396
	8400K01	3.4 [0.13]	–	11.6 [0.46]	12.7 Hex [0.50]	10–32	10–32	Al. hard anodized	8702, 8703, 8704, 8705, 8784, 8786
	8400K02	6.0 [0.24]	–	12.4 [0.49]	19.1 Hex [0.75]	10-32	6-32	Al. hard anodized	8766A50
	8400K03	5.5 [0.22]	–	12.8 [0.50]	19.1 Hex [0.75]	10–32	M6	Al. hard anodized	8688, 8702, 8703, 8704, 8705, 8784, 8786
	8400K04	5.2 [0.20]	–	12.3 [0.48]	12.7 Hex [0.50]	5–40	M6	Al. hard anodized	8766A250/500/1K0, 8763
	8400K05	5.9 [0.23]	–	13.3 [0.52]	19.1 Hex [0.75]	6-32	M6	Al. hard anodized	8766A50
	8400K06	5.3 [0.21]	–	11.4 [0.45]	12.7 Hex [0.50]	10–32	5–40	Al. hard anodized	8766A250/500/1K0, 8763
	8400K07	5.1 [0.20]	–	13.2 [0.52]	22.2 Hex [0.87]	10–32	10–32	Al. hard anodized	8762

Accessories

Mounting

Isolated mounting pads – see data sheet 8400_000-281 for more information

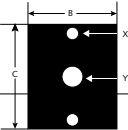
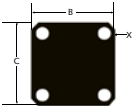
Technical data	Type	A mm [in]	B mm [in]	C mm [in]	D mm [in]	THD. X	THD. Y	Material	Recommended Sensor Types
	8466K02	6.4 [0.25]	–	10.2 [0.40]	22.2 Hex [0.87]	10–32	10–32	Al. hard anodized	8396
	8466K06	6.4 [0.25]	–	10.2 [0.40]	9.53 Hex [0.37]	10–32	10–32	Al. hard anodized	8742, 8743
	8466K07	5.1 [0.20]	–	7.6 [0.30]	8.89 Hex [0.35]	5–40	5–40	Al. hard anodized	8730
	8464K01	7.6 [0.30]	21.6 [0.85]	25.4 [1.0]	–	4–40	–	Al. hard anodized	8316
	8464K02	7.6 [0.30]	21.6 [0.85]	25.4 [1.0]	–	4–40	10–32	Al. hard anodized	8316
	800M144	4.8 [0.19]	15.9 [0.63]	15.9 [0.63]	–	4–40	–	Al. hard anodized	8793, 8794 (adhesive mount)
	800M154	4.8 [0.19]	15.9 [0.63]	15.9 [0.63]	–	hole	–	Al. hard anodized	8793, 8794 screw mount 4 x 8446AE4 or 4 x 8446AM4 isolated screw kits to be ordered separately



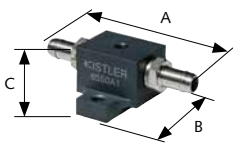

















Water cooled mounting adapter - see data sheet 8550_003-249e

Technical data	Type	A mm [in]	B mm [in]	C mm [in]	Weight with fittings	Max base temperature
	8550A1	59.7 [2.35]	37.3 [1.47]	21.1 [0.83]	36 grams	580°C [1 100°F]

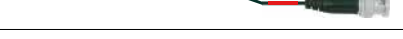
Accessories – cables

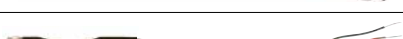
Cables

Cables – see data sheet 1511_000-471 for more information

Technical data	Types	Connection A	Connection B	Length (m)	Dia. mm [in]	Description
	1511A...	BNC pos.	BNC pos.	1/sp	3.1 [0.12]	Used for charge amplifier and coupler output signals
	1534A...K00	¼–28, 4 pin neg.	pigtail	2/5/10/sp	2.5 [0.10]	Flexible, silicone jacketed
	1578A...*	¼–28, 4 pin neg.	¼–28, 4 pin pos.	2/sp	2.5 [0.10]	Extension cable, fluoropolymer jacketed (low outgassing Type 1578M011SP also available)
	1592A...	¼–28, 4 pin neg.	¼–28, 4 pin neg.	2/4/sp	2.5 [0.10]	General purpose extension cable, fluoropolymer jacketed
	1592M1...**	¼–28, 4 pin neg.	pigtail	2/sp	2.5 [0.10]	Fluoropolymer jacketed for usage with Type 8316A... (IP68 Type 1592M1Q1, and low smoke Type 1592M2... also available)
	1601B...	BNC pos.	BNC pos.	1/2/5/10/20/sp	3.1 [0.12]	High impedance charge mode cables, commonly used as extension cables
	1603B...	BNC neg.	BNC pos.	2/5/10/20/sp	3.1 [0.12]	High impedance charge mode cables, commonly used as extension cables
	1631A...	10–32 pos.	BNC pos.	1/2/3/5/sp	2.0 [0.08]	High impedance charge mode cables, fluoropolymer jacketed
	1631C...	10–32 pos.	BNC pos.	1/2/3/5/10/20/sp	2.0 [0.08]	Low noise, high impedance charge mode cables, fluoropolymer jacketed
	1631CRK01SP	10–32 pos.	BNC pos.	sp	1.95 [0.077]	Low noise, high impedance charge mode cables, PTFE insulation & FPM jacketed
	1632A...	10–32 pos. hex nut	BNC pos.	3/7/10/sp	2.0 [0.078]	Low noise, high impedance charge mode cables, fluoropolymer jacketed
	1635A...	10–32 pos.	10–32 pos.	1/2/3/5/sp	2.0 [0.08]	High impedance charge mode cables, fluoropolymer jacketed
	1637C...	10–32 pos.	10–32 neg.	2/5/sp	2.0 [0.078]	Low noise, high impedance charge mode extension cables, fluoropolymer jacketed
	1635C...	10–32 pos.	10–32 pos.	1/2/3/5/8/sp	2.0 [0.08]	Low noise, high impedance charge mode cables, fluoropolymer jacketed
	1641Asp	10–32 pos.	BNC pos.	sp	2.0 [0.08]	High impedance charge mode cables, fluoropolymer jacketed
	1734A...K04*	¼–28, 4 pin neg.	(3x) BNC pos.	1/3/5/10	1.8 [0.07]	High temperature, ultra flexible IEPE triaxial cable with silicone jacket (low outgassing Type 1734ALK04SP also available)
	KIG4898C...Q1	¼–28, 4 pin neg., IP68	(3x) BNC pos.	3/7/15/sp	2.5 [0.10]	High temperature, triaxial accelerometer cable, fluoropolymer jacketed with water tight connector (IP68)
	1756CK00sp	¼–28, 4 pin neg.	pigtail	sp	2.5 [0.10]	Low outgassing signal output cable for triaxial voltage mode accelerometers
	1756C...K04*	¼–28, 4 pin neg.	(3x) BNC pos.	3/5/10/20/sp	2.5 [0.10]	High temperature, triaxial accelerometer cable, fluoropolymer jacketed (low outgassing Type 1756CLK04SP also available)
	1756C...K05	¼–28, 4 pin neg.	(3x) 10–32 pos.	3/5/10/20/sp	2.5 [0.10]	High temperature, triaxial accelerometer cable, fluoropolymer jacketed
	1761B/C...	10–32 pos.	BNC pos.	1/2/3/5/sp	2.0 [0.08]	Fluoropolymer insulated, voltage mode cables















* Refer to data sheet 000-471e for low outgassing version

** Refer to data sheet 000-471e for IP68 waterproof and low smoke versions

Accessories

Cables

Cables – see data sheet 1511_000-471 for more information

Technical data	Types	Connection A	Connection B	Length (m)	Dia. mm[in]	Description
	1762B...	10–32 pos.	10–32 pos.	1/2/3/5/sp	2.0 [0.08]	Fluoropolymer insulated, voltage mode cables
	1766AK01sp	5-44 pos.	10–32 neg.	sp	1.5 [0.06]	Type 8715A/B... mating cable
	1766AK03sp	5-44 pos.	10-32 pos.	sp	1.95 [0.077]	Low noise, high impedance charge mode cables, PTFE insulation & FPM jacketed
	1766AK04sp	5-44 pos.	BNC pos.	sp	1.95 [0.077]	Low noise, high impedance charge mode cables, PTFE insulation & FPM jacketed
	1768A...K01	10-32 pos.	BNC pos.	1/2/3/5/sp	2.0 [0.08]	Flexible PVC jacketed
	1768A...K02	10-32 pos.	10-32 pos.	1/2/3/5/sp	2.0 [0.08]	Flexible PVC jacketed
	1784AK02...*	M4.5, 4 pin neg.	¼–28, 4 pin pos.	0.50/sp	1.5 [0.06]	Extension cables for triaxial sensors (Types 8763, 8764, 8765, 8766), fluoropolymer jacketed
	1784B...K03*	M4.5, 4 pin neg.	(3x) BNC pos.	1/3/5/10	1.5 [0.06]	For triaxial sensors (Types 8763, 8764, 8765, 8766), fluoropolymer jacketed (low outgassing Type 1784BLK03SP also available)
	1784M015sp	M4.5, 4 pin neg.	pigtail	sp	1.5 [0.06]	Low outgassing signal output cable for miniature 4 pin connector triaxial voltage mode accelerometers
	1784M016sp	M4.5, 4 pin neg.	¼-28, 4 pin pos.	sp	1.5 [0.06]	Low outgassing extension cables for triaxial sensors (Types 8763, 8764, 8765, 8766), fluoropolymer jacketed
	1784M017sp	M4.5, 4 pin neg.	¼-28, 4 pin pos.	sp	1.5 [0.06]	Flexible extension cables for triaxial sensors (Types 8763, 8764, 8765, 8766), flexible PVC jacketed
	1786Dsp	¼–28, 4 pin neg.	(2x) Banana Jacks for power, (1x) BNC pos. signal out	sp max. 10 m	2.5 [0.10]	Breakout power supply cable, fluoropolymer jacketed
	1792A...K01****	9 pin circular neg.	9 pin D-Sub pos.	2/5/10/sp	4.6 [0.18]	Mating cable: Type 8396A (braided Type 1792A...KB01 also available)
	1792A...K00****	9 pin circular neg.	pigtail	2/5/10/sp	4.6 [0.18]	Mating cable: Type 8396A (braided Type 1792A...KB00, and low smoke Type 1792A...K10 also available)
	1794A	9 pin D-Sub neg.	(2x) Banana Jacks for power, (3x) BNC pos. signal out	2	2.5 [0.10]	Breakout power supply cable, fluoropolymer jacketed mating Type 8396A sensors

*** Refer to data sheet 000-471e for low outgassing or flexible versions

**** Refer to data sheet 000-471e for low smoke or braided versions

Accessories

Connector adaptors

Connector adaptors				
Technical data	Types	Connection A	Connection B	Connection C
	1701	BNC neg.	BNC neg.	–
	1702	Solder terminals	KIAG 10–32 pos.	–
	1721	KIAG 10–32 neg.	BNC pos.	–
	1723	KIAG 10–32 neg.	TNC pos.	–
	1725	KIAG 10–32 neg.	BNC neg.	–
	1729	KIAG 10–32 neg.	KIAG 10–32 neg.	–
	1743	BNC neg.	BNC neg.	BNC pos.

VascoMax is a registered trademark of Teledyne Vasco.

Piezoelectric theory

Piezoelectric effect

Although the piezoelectric effect was discovered by Pierre and Jacques Curie in 1880, it remained a mere curiosity until the 1940's. The property of certain crystals to exhibit electrical charges under mechanical loading was of no practical use until very high input impedance amplifiers enabled engineers to amplify their signals. In the 1950's, electrometer tubes of sufficient quality became available and the piezoelectric effect was commercialized.

Walter P. Kistler patented the charge amplifier principle in 1950 and gained practical significance in the 1960's. The introduction of highly insulating materials such as fluoropolymer and thermo-setting plastic greatly improved performance and propelled the use of piezoelectric sensors into virtually all areas of modern technology and industry.

Piezoelectric measuring systems are active electrical systems. That is, the crystals produce an electrical output only when they experience a change in load. For this reason, they cannot perform true static measurements. However, it is a misconception that piezoelectric instruments are suitable for only dynamic measurements. Quartz transducers, paired with adequate signal conditioners, offer excellent quasi-static measuring capability. There are countless examples of applications where quartz based sensors accurately and reliably measure quasi-static phenomena for minutes and even hours.

Applications of piezoelectric instruments

Piezoelectric measuring devices are widely used today in the laboratory, on the production floor, and embedded within as original equipment. They are used in almost every conceivable application requiring accurate measurement and recording of dynamic changes in mechanical variables, such as pressure, force and acceleration. The list of applications continues to grow including:

- **Aerospace:** Modal testing, wind tunnel and shock tube instrumentation, landing gear hydraulics, rocketry, structures, ejection systems, and cutting force research
- **Ballistics:** Combustion, explosion, detonation, and sound pressure distribution
- **Biomechanics:** Multi-component force measurement for orthopedic gait and posturography, sports, ergonomics, neurology, cardiology, and rehabilitation
- **Engine Testing:** Combustion, gas exchange and injection, indicator diagrams, and dynamic stressing
- **Engineering:** Materials evaluation, control systems, reactors, building structures, ship structures, auto chassis structural testing, shock and vibration isolation, and dynamic response testing
- **Industrial/Factory:** Machine systems, metal cutting, press and crimp force, automation of force-based assembly operations, and machine health monitoring
- **OEMs:** Transportation systems, plastic molding, rockets, machine tools, compressors, engines, flexible structures, oil/gas drilling and shock/vibration testers

Piezoelectric sensors (Quartz-based)

The vast majority of Kistler sensors utilize quartz as the sensing element. As discussed in other sections of this catalog, Kistler also manufactures sensors which utilize piezoceramic elements and micro machined silicon structures. The discussion in this section, however, will be limited to quartz applications.

Quartz piezoelectric sensors essentially consist of thin slabs or plates cut in a precise orientation to the crystal axes depending upon the application. Most Kistler sensors incorporate a quartz element, which is sensitive to either compressive or shear loads. The shear cut is used for patented multi-component force and acceleration measuring sensors. Other specialized cuts include the transverse cut for some pressure sensors and the patented polystable cut for high temperature pressure sensors. See Fig. 2 and Fig. 3 (on next page).

Although the following discussion focuses on acceleration applications, the response function for force and pressure sensors has essentially the same form. In fact, many force applications are closely related to acceleration. Alternatively, pressure sensors are designed to minimize or eliminate (by direct compensation of the charge output) the vibration effect. Contact Kistler directly for more information regarding this subject.

The finely lapped quartz elements are assembled either singularly or in stacks and are usually preloaded with a spring sleeve. The quartz package generates a charge signal (measured in pico Coulombs), which is directly proportional to the sustained force. Each sensor type uses a quartz configuration that is optimized and ultimately calibrated for its particular application (force, pressure, acceleration or strain). Refer to the appropriate section for important design aspects depending on the application.

Quartz sensors exhibit remarkable properties which justify their large scale use in research, development, production and testing. They are extremely stable, rugged and compact. Of the large number of piezoelectric materials available today, quartz is employed preferably in sensor designs due to the following unique properties:

- High material stress limit, approximately 150 N/mm²
- Temperature resistance up to 500°C
- Very high rigidity, high linearity, and negligible hysteresis
- Near constant sensitivity over a wide temperature range
- Ultra-high insulation resistance

High and Low impedance

Kistler supplies two types of piezoelectric sensors: high and low impedance. High impedance types have a charge output, which requires a charge amplifier or external impedance converter for charge-to-voltage conversion. Low impedance types use the same piezoelectric sensing element as high impedance types and also incorporate a miniaturized, built-in, charge-to-voltage converter. Low impedance types require an external power supply coupler to energize the electronics and decouple the subsequent DC bias voltage from the output signal.

Dynamic behavior of sensors

Piezoelectric sensors for measuring pressure, force and acceleration may be regarded as under-damped, spring mass systems with a signal degree of freedom. They are modeled by the classical second order differential equation whose solution is:

$$\frac{a_o}{a_b} \cong \frac{1}{\sqrt{[1 - (\frac{f}{f_n})^2]^2 + (\frac{1}{Q^2})(\frac{f}{f_n})^2}}$$

Where:

- f_n undamped natural (resonant) frequency (Hz)
- f frequency at any given point of the curve (Hz)
- a_o output acceleration
- a_b mounting base or reference acceleration ($f/f_n = 1$)
- Q factor of amplitude increase at resonance

Quartz sensors have a Q of approximately 10 ... 40. Therefore, the phase angle can be written as:

$$\text{phase lag (deg)} \cong \frac{60}{Q} \left(\frac{f}{f_n} \right) \text{ for } \frac{f}{f_n} \leq \frac{2}{5}$$

A typical frequency response curve is shown in Fig. 4. As shown, about 5% amplitude rise can be expected at approximately 1/5 of the resonant frequency (f_n). Low-pass (LP) filtering can be used to attenuate the effects of this. Many Kistler signal conditioners (charge amplifiers and couplers) have plug-in filters designed for this purpose.

Charge amplifiers

Generally, the charge amplifier consists of a high-gain inverting voltage amplifier with a MOSFET or J-FET at its input to achieve high insulation resistance. A simplified model of the charge amplifier is shown in Fig. 5. The effects of R_t and R_i will be discussed below. Neglecting their effects, the resulting output voltage becomes:

$$V_o = \frac{-q}{C_r} \times \frac{1}{1 + \frac{1}{AC_r} (C_t + C_r + C_c)}$$

For sufficiently high open loop gain, the cable and sensor capacitance can be neglected and the output voltage depends only on the input charge and the range capacitance:

$$V_o = \frac{-q}{C_r}$$

In summary, the amplifier acts as a charge integrator which compensates the sensor's electrical charge with a charge of equal magnitude and opposite polarity and ultimately produces a volt-

Fig. 2: Quartz bar

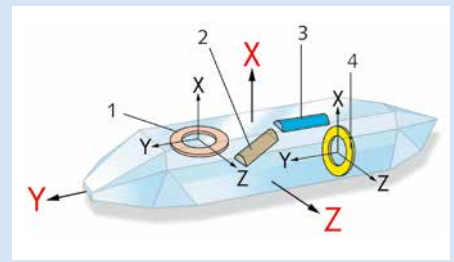

Fig. 3: Piezoelectric effect

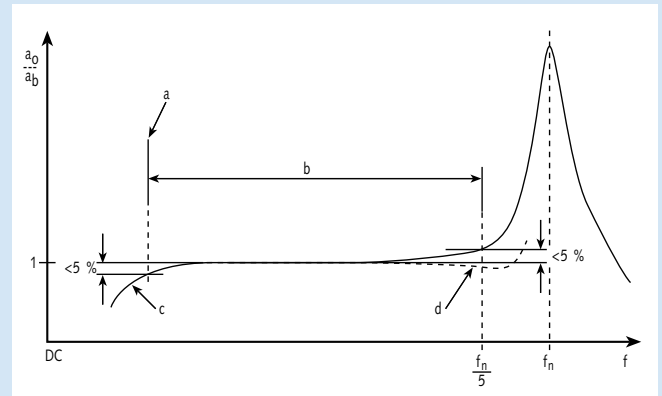
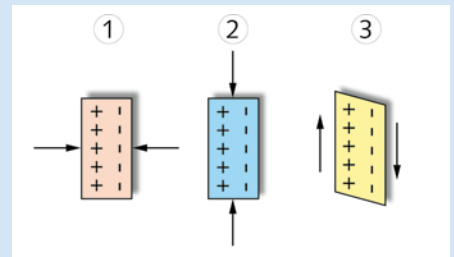

Fig. 4: Typical frequency response curve

- a = low frequency limit determined by RC roll-off characteristics
- b = usable frequency range
- c = HP filter
- d = LP filter

age across the range capacitor. In effect, the purpose of the charge amplifier is to convert the high impedance charge input (q) into a usable output voltage (V_o).

Time constant and drift

Two of the more important considerations in the practical use of charge amplifiers are time constant and drift. The time constant is defined as the discharge time of an AC coupled circuit. In a period of time equivalent to one time constant, a step input will decay to 37% of its original value.

Time Constant (TC) of a charge amplifier is determined by the product of the range capacitor (C_r) and the time constant resistor (R_t):

$$TC = R_t C_r$$

Drift is defined as an undesirable change in output signal over time, which is not a function of the measured variable. Drift in a charge amplifier can be caused by low insulation resistance at the input (R_i) or by leakage current of the input MOSFET or J-FET.

Drift and time constant simultaneously affect a charge amplifier's output. One or the other will be dominant. Either the charge amplifier output will drift towards saturation (power supply) at the drift rate or it will decay towards zero at the time constant rate.

Many Kistler charge amplifiers have selectable time constants which are altered by changing the time constant resistor (R_t). Several of these charge amplifiers have a "Short", "Medium" or "Long" time constant selection switch. In the "Long" position, drift dominates any time constant effect. As long as the input insulation resistance (R_i) is maintained at greater than $10^{13} \Omega$, the charge amplifier (with MOSFET input) will drift at an approximate rate of 0.03 pC/s. Charge amplifiers with J-FET inputs are available for industrial applications but have an increased drift rate of about 0.3 pC/s.

In the "Short" and "Medium" positions, the time constant effect dominates normal leakage drift. The actual value can be determined by referring to the appropriate operation/instruction manual supplied with the unit. Kistler charge amplifiers without "Short", "Medium" or "Long" time constant selection operate in the "Long" mode and drift at the rates listed above. Some of these units can be internally modified for shorter time constants to eliminate the effects of drift.

Frequency and time domain considerations

When considering the effects of time constant, the user must think in terms of either frequency or time domain. The longer the time constant, the better the low-end frequency response and the longer the usable measuring time. When measuring vibration, time constant has the same effect as a single pole, high-pass (HP) filter whose amplitude and phase are:

$$\frac{V_o}{V_{in}} = \frac{2\pi f (TC)}{\sqrt{1 + [2\pi f (TC)]^2}}$$

$$\text{phase lead (deg)} = \arctan \frac{1}{2\pi f (TC)} \cong 80 \sqrt{\frac{V_{in} - V_o}{V_{in}}}$$

For example, the output voltage has declined approximately 5% when $f_x (TC)$ equals 0.5 and the phase lead is 18° .

When measuring events with wide (or multiple) pulse widths, the time constant should be at least 100 x's longer than the total event duration. Otherwise, the DC component of the output signal will decay towards zero before the event is completed.

Selection matrix

Other design features incorporated into Kistler charge amplifiers include range normalization for whole number output, low-pass filters for attenuating sensor resonant effects, electrical isolation for minimizing ground loops and digital/computer control of setup parameters.

Low impedance piezoelectric sensors

Piezoelectric sensors with miniature, built-in, charge-to-voltage converters are identified as low impedance units throughout this catalog. These units utilize the same types of piezoelectric sensing element(s) as their high impedance counterparts. Piezotron, PiezoBeam, Ceramic Shear and K-Shear are all forms of Kistler low impedance sensors.

In 1966, Kistler developed the first commercially available piezoelectric sensor with internal circuitry. This internal circuit is a patented design called Piezotron. This circuitry employs a miniature MOSFET input stage followed by a bipolar transistor stage that operates as a source follower (unity gain). A monolithic integrated circuit is utilized, which incorporates these circuit elements. This circuit has very high input impedance ($10^{14} \Omega$) and low output impedance (100Ω), which allows the charge generated by the quartz element to be converted into a usable voltage. The Piezotron design also has the great virtue of requiring only a single lead for power-in and signal-out. Power to the circuit is provided by a Kistler coupler (power supply), which supplies a source current (2 ... 18 mA) and energizing voltage (20 ... 30 VDC). Certain (extreme) combinations of other manufacturer supply current and energizing voltage (i.e. 20 mA and 18 VDC, respectively), together with actual bias level, may restrict operating temperature range and voltage output swing. Contact Kistler for details. Connection is as shown in Fig. 6. A Kistler coupler and cable is all that is needed to operate a Kistler low impedance sensor.

The steady-state output voltage is essentially the input voltage at the MOSFET gate, plus any offset bias adjustment. The voltage sensitivity of a Piezotron unit can be approximated by:

$$V_o \cong \frac{q}{C_q + C_r + C_G}$$

The range capacitance (C_r) and time constant resistor (R_t) are designed to provide a predetermined sensitivity (mV/g), as well as upper and lower usable frequency. The exact sensitivity is measured during calibration and its value is recorded on each unit's calibration certificate. Since its invention, the Piezotron design has been adapted by manufacturers worldwide and has become a widely used standard for the design of sensors measuring acceleration, force and pressure. The concept has become known by many names besides Piezotron, such as low impedance or voltage mode. A number of 'brand names' have emerged by other manufacturers.

PiezoBeam incorporates a bimorph ceramic element and a miniature hybrid charge amplifier for the charge-to-voltage conversion. K-Shear is the newest member of the Kistler low impedance family, which utilizes a shear quartz element together with the Piezotron circuitry.

Capacitive accelerometer theory

Time constant

The time constant of a Piezotron sensor is:

$$TC = R_t (C_q + C_r + C_G)$$

A PiezoBeam time constant is the product of its hybrid charge amplifier's range capacitor and time constant resistor. Time constant effects in low impedance sensors and in charge amplifiers are the same. That is, both act as a single pole, high-pass filter as discussed previously.

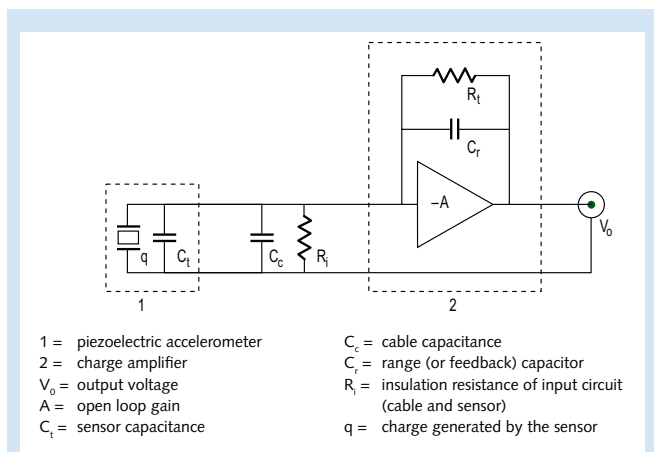

Fig. 5: Simplified charge amplifier model

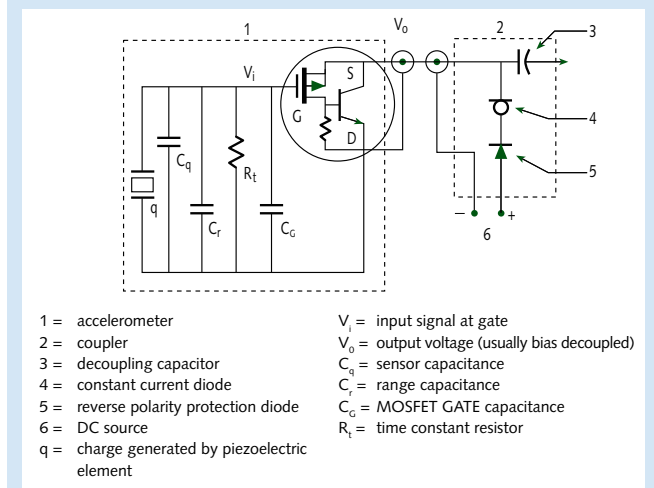

Fig. 6: Piezotron circuit & coupler

The fundamental principle of operation for a capacitive accelerometer is the property that a repeatable change in capacitance exists when a sensing structure is deflected due to an imposed acceleration.

The acceleration creates a force (F) acting on a suspended flexure of known mass (m). The flexure moves predictably and in a controlled manner dictated by its stiffness (k). A gas-filled gap exists between surrounding electrodes, as shown in Fig. 7. The inertial force can be calculated from Newton's Second Law of Motion as:

$$F = ma \quad [\text{Eq. 1}]$$

Knowing the force, a displacement of the flexure can be estimated using a simple spring calculation:

$$x = F/k \quad [\text{Eq. 2}]$$

However, in practice, Finite Element Analysis (FEA), is employed to model the complicated spring designs. This displacement alters the gaps on either side of the flexure in an equal but opposite proportion. The distance between the flexure and surrounding electrodes (l) is then the nominal [zero g] spacing (d) \pm the spring deflection (x) or:

$$l_1 = d + x \quad \& \quad l_2 = d - x \quad [\text{Eq. 3}]$$

Knowing the electrode area (A) and the permittivity constant of the gas (E), the capacitance formed by the gaps can be determined from:

$$C_1 = A \epsilon / l_1 \quad \& \quad C_2 = A \epsilon / l_2 \quad [\text{Eq. 4}]$$

This capacitance difference causes an imbalance in a bridge network of the internal electronic circuit. Internal signal conditioning incorporates AC excitation and synchronous demodulation. In addition, it provides power for the accelerometer element and outputs an analog voltage proportional to the acceleration signal.

The key operating principle of Fig. 8 is that a variable capacitive element unbalances a bridge relative to applied acceleration. The electronic action is summarized as follows:

- A voltage regulator stabilizes the accelerometer sensitivity and assures internal functions remain constant despite the supply voltage level
- A square wave generator produces excitation for the bridge circuit
- A capacitive bridge produces two signals with amplitudes relative to the applied acceleration
- The opposing signals are summed by the synchronous demodulator to form a voltage proportional to applied acceleration
- A pre-amplifier provides gain
- A built-in, low-pass filter attenuates unwanted signals above the operating frequency range

Kistler micromachined K-Beam accelerometer sensing elements consist of very small inertial mass and flexure elements chemically etched from a single piece of silicon. The seismic mass is supported by flexure elements between two plates, which act as electrodes. As the mass deflects under acceleration, the capacitance between these plates changes. Under very large accelerations (or shocks), the motion of the mass is limited by the two stationary plates, thereby limiting the stress placed on the suspension and preventing damage. The typical design is shown in Fig. 9.

The damping of the mass by an entrapped gas creates a 'squeeze film' providing an optimized frequency response over a wide temperature range. Additionally, its differential capacitive design assures immunity to thermal transients. The affect of damping is shown in Fig. 10a and appropriate damping is tuned with a specific spring mass system to achieve optimal frequency response (Fig. 10b).

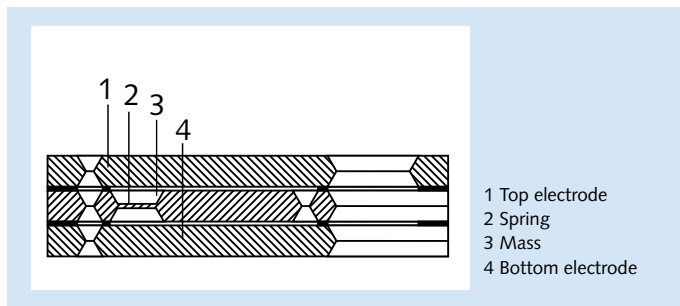

Fig. 7: Typical capacitive accelerometer arrangement

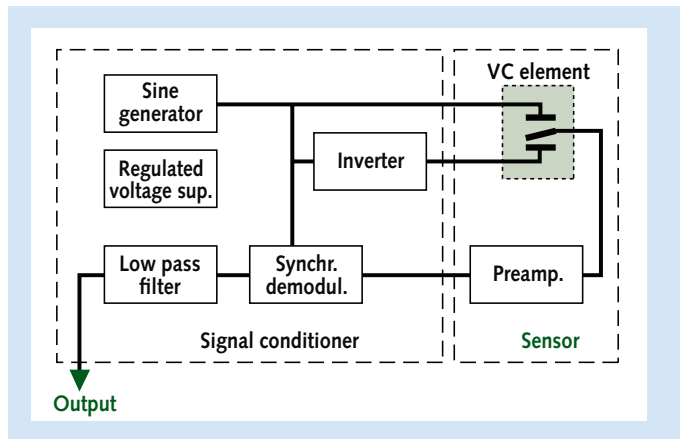

Fig. 8: Electrical schematic

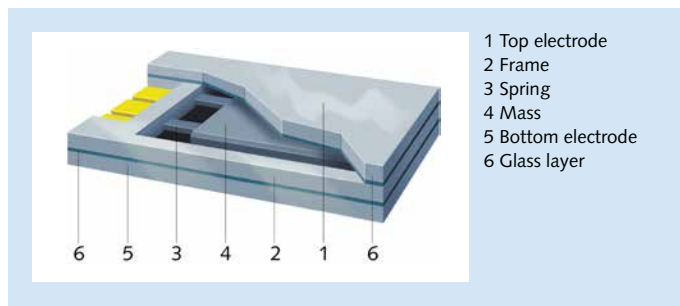

Fig. 9: MEMS variable capacitance accelerometer

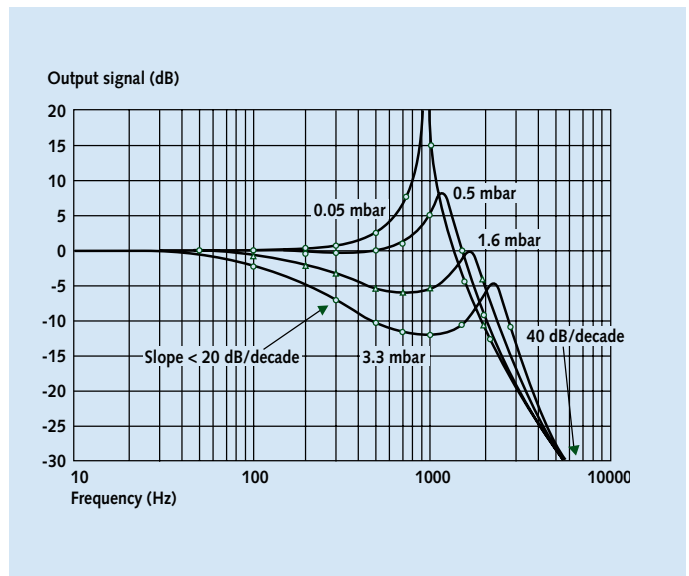

Fig. 10a: Effect of damping

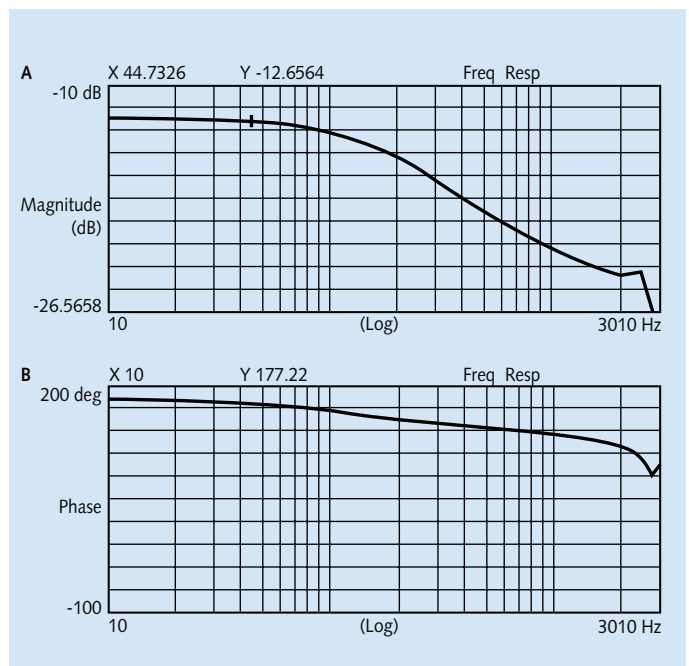

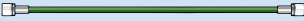
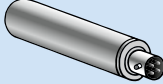

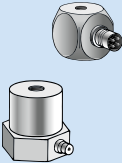
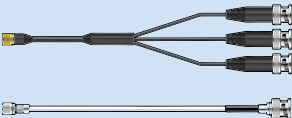

Fig. 10b: Tuned system

Measuring chains

Charge output sensor and IEPE converter

	Measuring	Connecting	Amplifying
Charge input sensor	Type 82... 	Type 1635C... 	Type 5050B... 

IEPE sensors and customer IEPE compatible DAQ

Types 86... 87... 	Types 1761B... 1734A... 1756C... 1784B... 	
---	---	---

IEPE sensor and non-IEPE compatible DAQ

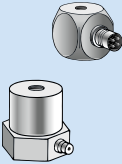
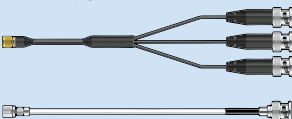
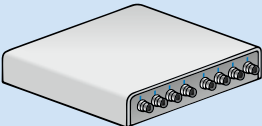
Types 86... 87... 	Types 1761B... 1736A... 1756C... 1784B... 	Type 51... IEPE Couplers Conditioning 
---	---	---

Charge output or IEPE sensor and Kistler LabAmp

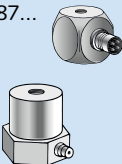
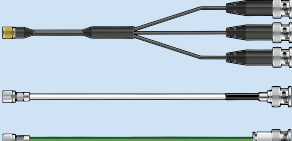
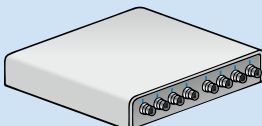
Types 82... 86... 87... 	Types 1631C... 1761B... 1756C... 	Type 5165A Conditioning and Data Acquisition 
--	---	--

Capacitive solutions

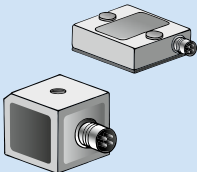
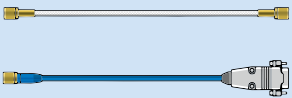
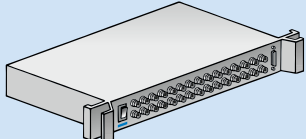
Types 83... 	Types 1592A/M1... 1792A... 	Type 5146A15 Conditioning 
--	--	---

Acquiring

Analyzing

Type 1511

IEPE Compatible Data Acquisition Unit
(customer supplied)

Laptop
(customer supplied)

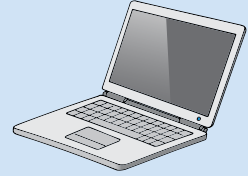
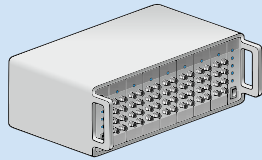

IEPE Compatible Data Acquisition Unit
(customer supplied)

Laptop
(customer supplied)

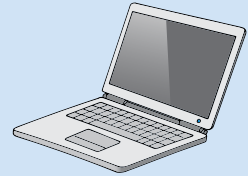
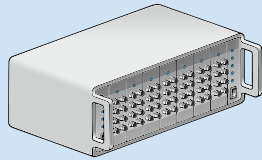

Type 1511

Non-IEPE Compatible Data Acquisition Unit
(customer supplied)

Laptop
(customer supplied)

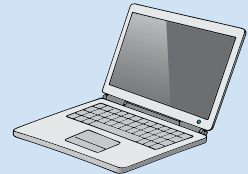
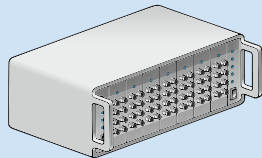

Type 5165A
Conditioning and Data Acquisition

Ethernet Cable

Notebook with LabAmp
Graphical User Interface (GUI)

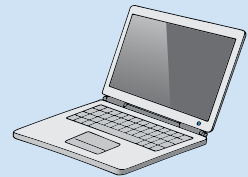
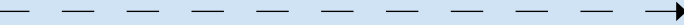

Type 1511
(or customer supplied)

Data Acquisition Unit
(customer supplied)

Laptop
(customer supplied)

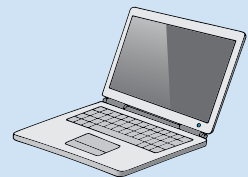
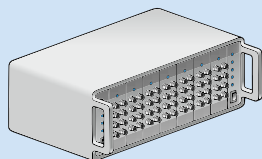
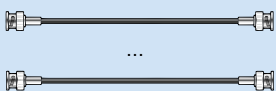

Glossary

Bias voltage

DC (no load or quiescent) output level of a low impedance sensor powered by constant current excitation.

Ceramic shear

Kistler piezoelectric accelerometer family which utilizes ceramic shear sensing elements.

Charge amplifier

Part of a measuring chain which converts the charge signal from the sensor into a proportional voltage signal or current signal.

Charge output

Output in pico Coulombs (pC) from a piezoelectric sensor without a built-in charge-to-voltage converter (see 'High Impedance').

Circuit integrity indication

A quick-look reference on couplers or dual mode charge amplifier for identifying whether a low impedance system has the proper bias voltage. Analog meters and multi-color LEDs are the most commonly used indicators.

Constant current excitation

Method of powering low impedance sensors to insure minimal sensitivity variation over a wide voltage range. A Piezotron coupler or any other IEPE type power supply may be used for this purpose.

Coupler

Electronic unit which supplies constant current excitation to low impedance sensors and decouples the subsequent bias voltage.

Crosstalk

Signal at the output of a sensor, produced by a measurand acting on the sensor, which is different from the measurand assigned to this output. For example, when a load in the Fy direction produces an Fz signal in a three-component sensor.

In terms of electrical devices, it is a measure for the signal impact acting from a channel to the neighboring ones.

Drift

Unwanted changes in the output signal independent of the measurand as a function of time.

Dual mode

Refers to a charge amplifier which can be used either with high impedance, charge output or with low impedance, voltage output sensors.

Ground isolation

High electrical resistance of a sensor between signal line and ground, or of a charge amplifier between connector screen and ground.

High impedance

Another term for a piezoelectric sensor with charge output (i.e. pC/mechanical unit).

Hysteresis

The maximum difference in output, at any measurand value within the specified range, when the value is approached first increasing and then decreasing measurand (source: ANSI / ISA-S37.1).

NOTE: The quartz crystal itself has a scarcely measurable hysteresis. However, the mechanical construction of the sensor can result in slight hysteresis. If the hysteresis is above the specified values (in %FSO), then the sensor is faulty or has not been correctly installed.

IEPE

Integrated Electronic PiezoElectric (see Piezotron).

Impedance converter

A miniature electronic unit with MOSFET input and bipolar output for converting high impedance, charge outputs (from a sensor) into low impedance, voltage outputs. Impedance converters can be built into the sensor (see 'Low Impedance') or can be used externally for special applications.

Impedance head

Sensor that simultaneously measures both force and acceleration during modal analysis testing.

Insulation resistance

Electric resistance of a sensor, cable or the input of a charge amplifier measured between the signal line and the connection ground (sensor body), while the test voltage is stated accordingly. The insulation resistance applies for piezoelectric sensor, strain gauge sensors and semiconductor sensors.

K-Beam

Kistler's solid-state, variable capacitance based line of accelerometers, which are suitable for measuring low frequencies or even steady-state conditions.

K-Shear

Kistler's piezoelectric accelerometer family. Low impedance accelerometer that utilizes quartz shear sensing element.

Linearity

Linearity is defined as the closeness of the calibration curve to a specified line (source: ANSI/ISA-S37.1).

Linearity represents the maximum deviation between ideal and actual output signal characteristics in relation to the measurand in a specific measuring range. It is expressed in percentage of the range of measurement signal (full-scale output).

NOTE: Quartz crystals produce an electric charge, which is exactly proportional to the load. However, unavoidable deviations occur due to the mechanical construction of the sensor.

Low impedance

Another name for a piezoelectric sensor with a miniature, built-in charge to voltage converter. Output is typically in mV/mechanical unit. K-Shear, Piezotron, and PiezoBeam are all forms of low impedance sensors.

Low-pass filter

Special type of filter that high frequency components of a measurement signal hides (electronic, mechanical, digital).

Measurand

Physical quantity, state or characteristic which is measured, e.g. force, torque, pressure, etc.

Glossary

Natural frequency

Frequency of free (not forced) oscillations of the entire sensor. In practice, the (usually lower) natural frequency of the entire mounting structure governs the frequency behavior.

Newton (N)

The metric unit of force measurement equivalent to 1 kg m s⁻² or 0.2248 lbf.

pico coulomb (pC)

A unit of electrical charge equivalent to 1x10⁻¹² ampere second.

PiezoBeam

Low impedance accelerometer; incorporates a bimorph ceramic element that generates an electrical charge when mechanically loaded.

Piezoelectric sensor

Sensor with element that generates an electrical charge when mechanically loaded.

PiezoStar

Kistler proprietary crystal used with IEPE accelerometers to provide ultra-low sensitivity shift with temperature.

Piezotron

Patented Kistler piezoelectric sensors with miniature, built-in impedance converters (see 'Impedance converter').

Polystable

Patented Kistler quartz element incorporated into pressure sensor designs for operating temperatures up to 660 °F.

Quasi-static

Describes the ability of Kistler sensors, charge amplifiers, and electrical devices to undertake time-variable and nearly time constant measurements (e.g. long-term measurements or DC-similar measurements).

Resonance frequency

Resonance frequency corresponds the frequency of an oscillating system, at which a resonance case is observed. Frequencies are called resonance frequencies of a system, when the amplitude of a system oscillation responds with a local maximum at constant excitation (forced oscillation).

Rise time

The length of time for the output of a sensor to rise from 10% to 90% of its final value as a result of a step-change of measurand.

Sealing

The degree of sealing as per EN 60529 is IP66 (commonly denoted as 'epoxy' sealing) IP67 ('epoxy/welded'), and IP68 ('hermetic').

Sensitivity

Nominal value or calibrated value stated in the calibration certificate of the change in the response of a sensor divided by the corresponding change in the value of the measurand.

TEDS

Transducer Electronic Data Sheet. Characteristic data stored digitally internal to sensor, IEEE 1451.4 compliant.

TEDS Versions

T	Default, IEEE 1451.4 V0.9 Template 0 (UTID 1)
T01	IEEE 1451.4 V0.9 Template 24 (UTID 116225)
T02	LMS Template 117, Free Format Point ID
T03	LMS Template 118, Automotive Format (Field 14 Geometry = 0)
T04	LMS Template 118, Aerospace Format (Field 14 Geometry = 1)
T05	P1451.4 V1.0 Template 25 - Transfer Function Disabled
T06	P1451.4 V1.0 Template 25 - Transfer Function Enabled

NOTE: Kistler recommends the versions T05 or T06 V1.0 Template 25 as it belongs to the latest revision of the IEEE 1451.4. Please verify with your DAQ manufacturer for compatibility.

Temperature coefficient of sensitivity

Change in the sensitivity, i.e. the slope of the best straight line, as a function of temperature. The temperature distribution in the sensor is assumed to be homogeneous, and in thermal equilibrium with the environment. PiezoStar sensors boast very low temperature coefficient of sensitivity (typically %/°F).

Time constant (TC)

The time constant describes the behaviour of a high-pass filter and represents the time after which the signal is reduced to 1/e of the output value.

NOTE: The time constant enables the measuring error to be estimated in relation to the measuring duration. You will find detailed information on time constants and sensitivity ranges in the operating instructions for your charge amplifier.

Example: The time constant depends on the measuring range selected on the charge amplifier. Possible values vary from approx. 0.01 s in the most sensitive range to approx. 100,000 s in the least sensitive range. The largest possible time constant must be selected for quasi-static measurements.

Threshold

Largest change in the measurand that produces a measurable change in the sensor output, while the change of the measurand takes place slowly and monotonically.

NOTE: In practice, the rule of thumb applies that the threshold is about two to three x's as large as the typical noise signal of a charge amplifier. This value can, however, only be achieved in dynamic measurements, whereas with quasi-static measurements, drift and environmental influences are limiting factors.

Transverse sensitivity

The output of an accelerometer caused by acceleration perpendicular to the measuring axis.

Voltage output

Output (in mV) from a piezoelectric sensor with a built-in charge-to-voltage converter (see 'Low impedance').



From professional advice on installation to speedy deliveries of spare parts: Kistler's comprehensive range of services and training is at your disposal across the globe

Service: customized solutions from A to Z

Kistler offers sales and service wherever automated manufacturing processes take place.

In addition to sensors and systems, Kistler offers a host of services – from professional advice on installation to speedy worldwide deliveries of spare parts. For an overview of the services we offer, visit www.kistler.com. For detailed information on our training courses, please contact our local distribution partners.

Kistler service at a glance

- Advice
- Support with system commissioning
- Process optimization
- Periodic onsite calibration of sensors
- Education and training events
- Development services

PiezoStar®, Piezotron®, PiezoSmart® and K-Beam® are registered trade marks of Kistler Holding AG.

At our customers' service across the globe

Thanks to Kistler's global sales and service network, we are always close to our customers. Approximately 2,200 employees at more than 60 locations are dedicated to the development of new measurement solutions and offer customized on-site support of individual applications.



Our representatives are here to help
Whether you would like a consultation or require support during installation – our website provides the contact information for your local representative.



Data sheets and documents
Use our Online Search to download data sheets, brochures or CAD data.

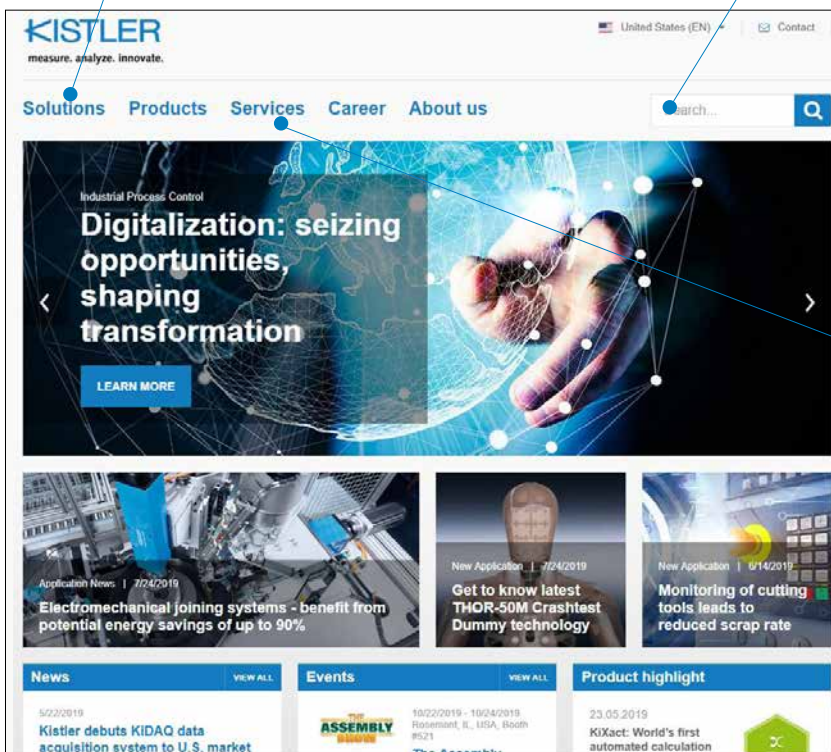

Education and training events
Education and training courses, during which our sensors and measuring systems are explained by Kistler experts, are the most efficient way for you to obtain the required user knowledge.



Find out more about our applications:
www.kistler.com/applications

Kistler Group
 Eulachstrasse 22
 8408 Winterthur
 Switzerland
 Tel. +41 52 224 11 11

Kistler Group products are protected by various intellectual property rights. For more details, visit www.kistler.com. The Kistler Group includes Kistler Holding AG and all its subsidiaries in Europe, Asia, the Americas and Australia.

Find your local contact at
www.kistler.com

KISTLER
 measure. analyze. innovate.